

Name	Signatur	Datum	Artikelnummer	Oberfläche: Roh
Ch. Häfig	CH	03.11.2022	60230-GU	
Werkstoff:				Blattformat
EPDM				A4
Gewicht 0,005 kg		Maßstab: 1,5:1	Version: 1	Blatt 1 von 4

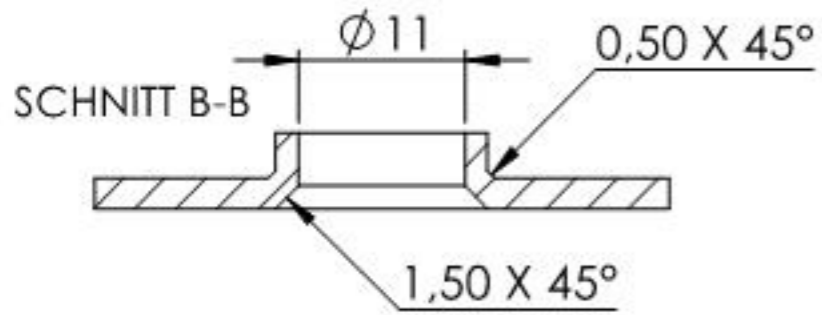

Name	Signatur	Datum	Artikelnummer	Oberfläche: Roh
Ch. Häfig	CH	03.11.2022	60230-GU Teil1	
Werkstoff:				Blattformat
EPDM				A4
Gewicht 0.003 kg		Maßstab: 1.5:1	Version: 1	Blatt 2 von 4

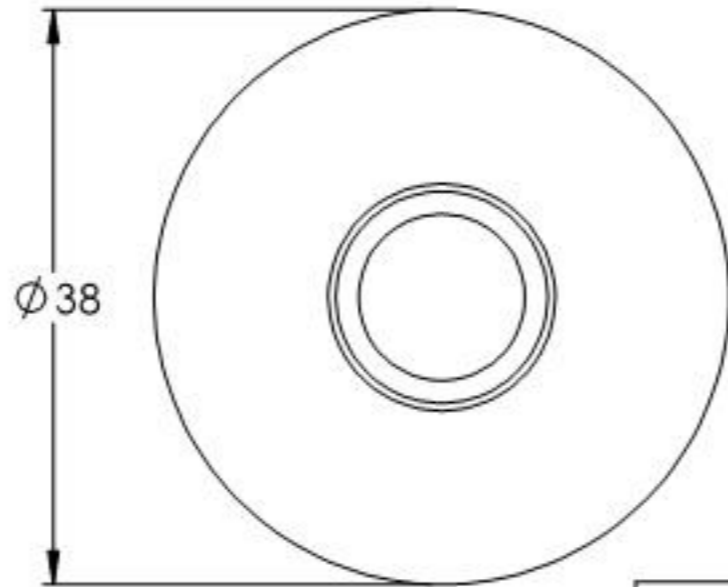
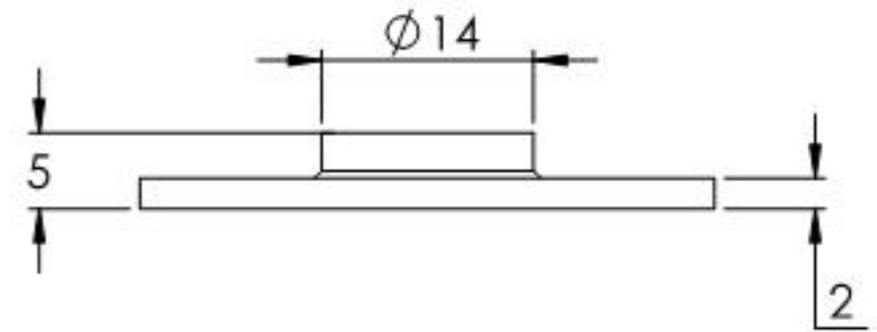
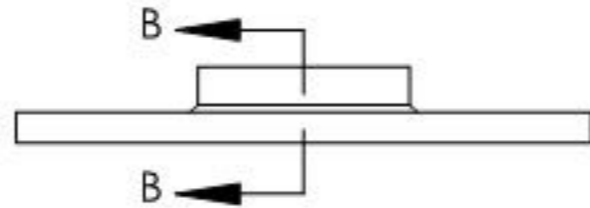
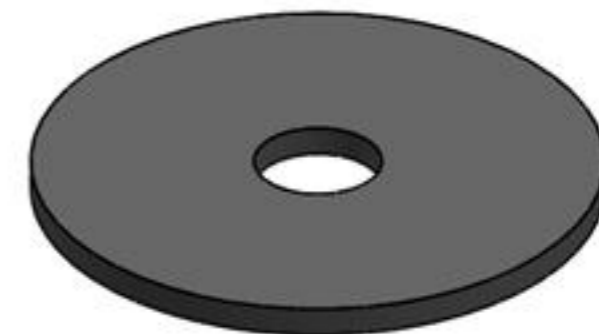
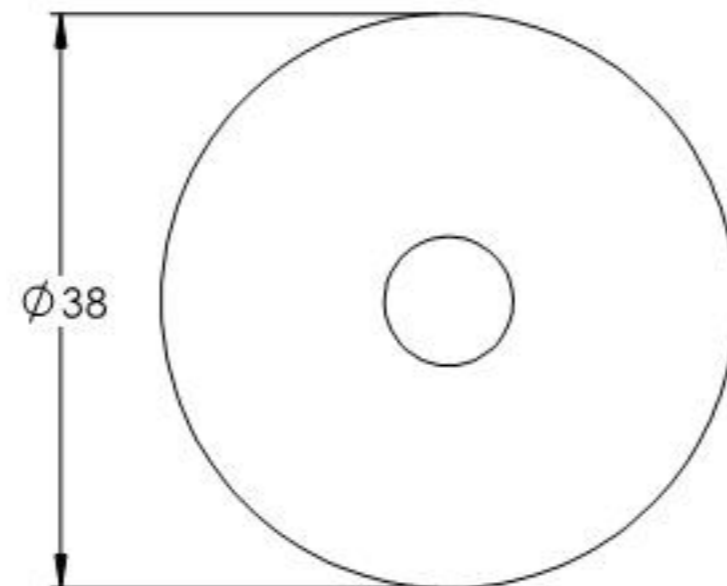
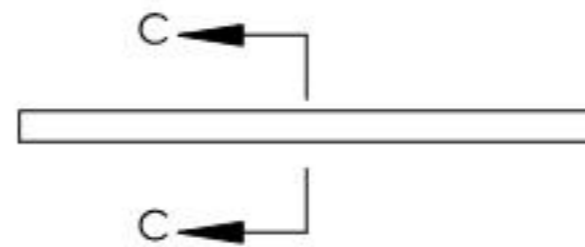
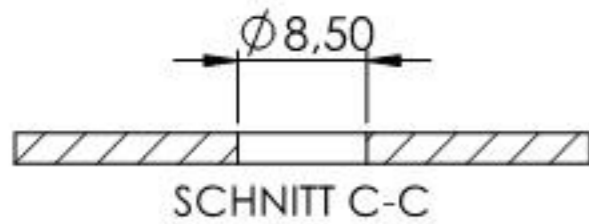

Name	Signatur	Datum	Artikelnummer	Oberfläche: Roh
Ch. Häfig	CH	03.11.2022	60230-GU Teil2	
Werkstoff: EPDM				Blattformat A4
Gewicht 0.003 kg		Maßstab: 1.5:1		Version: 1 Blatt 3 von 4