

R0,50

A dimension line with an arrow pointing to the rounded corner of the top view, indicating a radius of R0,50.

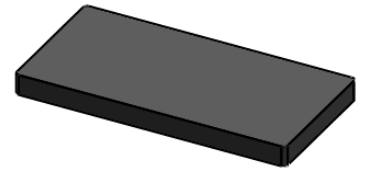

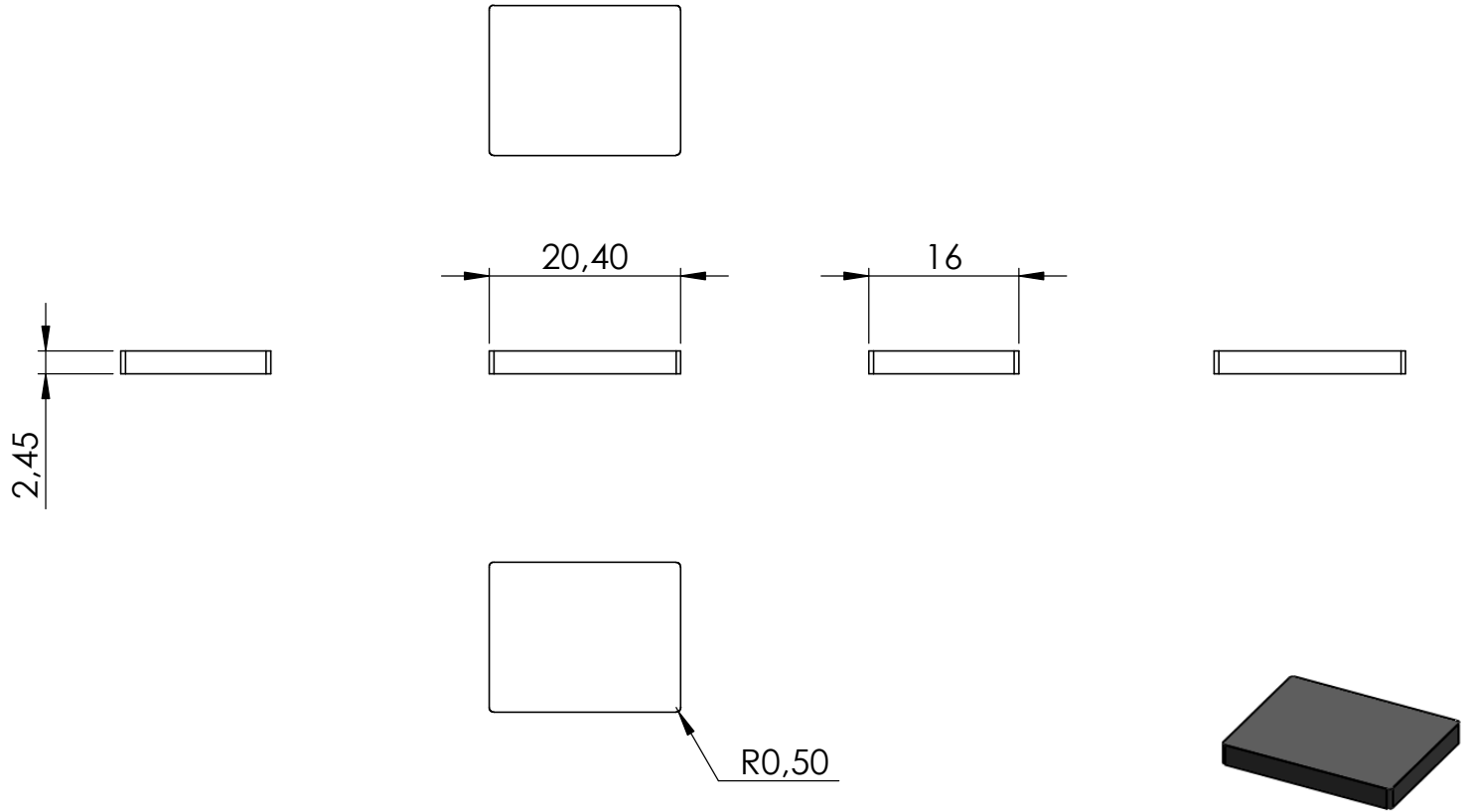

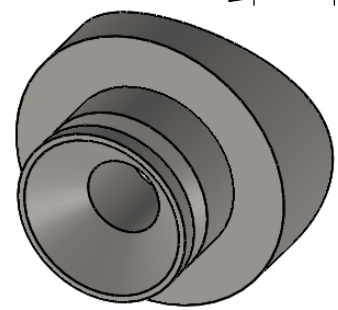
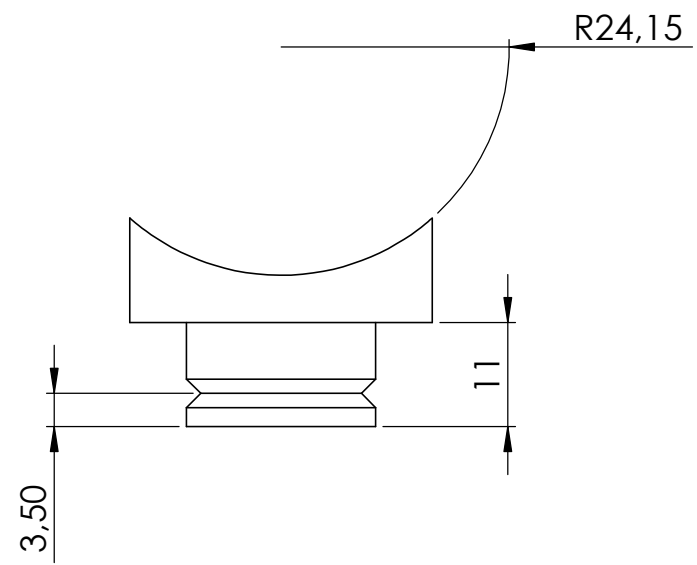
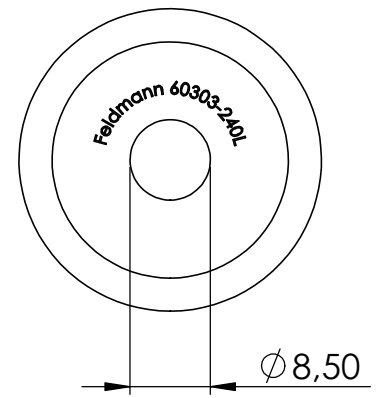
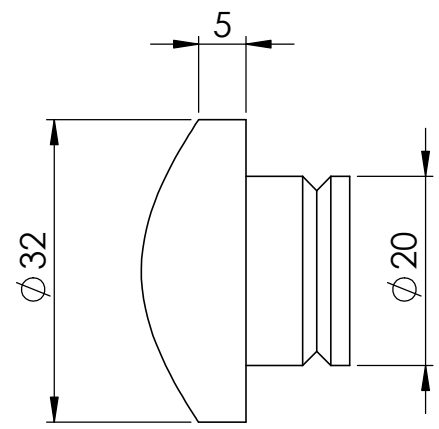
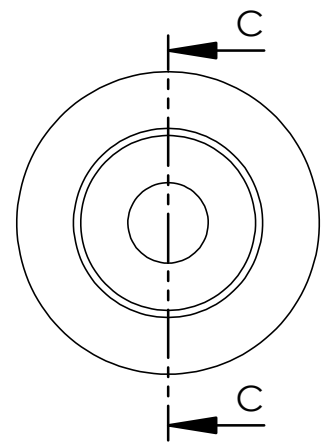
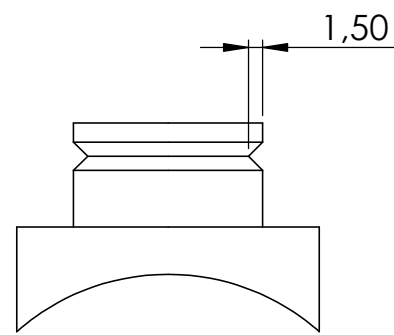
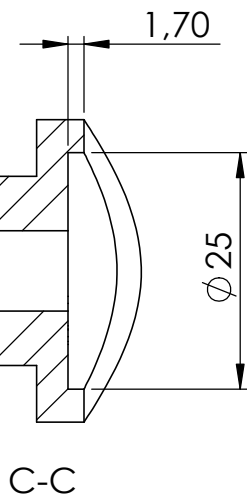
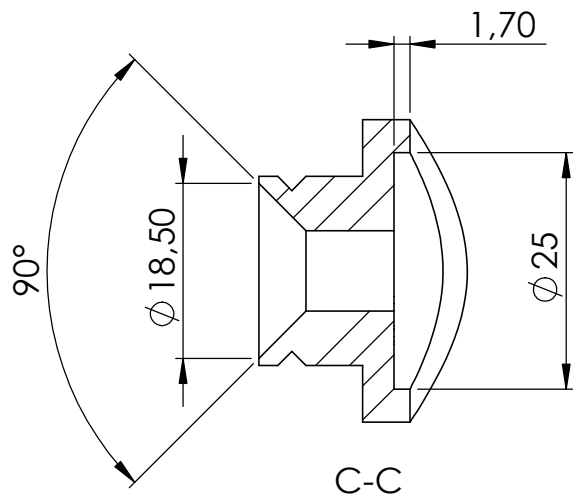

4	60303-240L Teil4	1
5	DIN 914 - M6 x 10-S	2
6	DIN 914 M6x6	1
7	DIN 7991 - M8 x 25 --- 25S	1

