

Name	Signatur	Datum	Artikelnummer	Oberfläche: Geschliffen Kam 240	
Ch. Hölg	CH	15.01.2024	70212-240		
Werkstoff:					Blattformat
I,430I (X5CrNi18-10)					A4
Gewicht: 0,285 kg		Maßstab: 1:5	Version: 1	Deutsch	Blatt 1 von 6

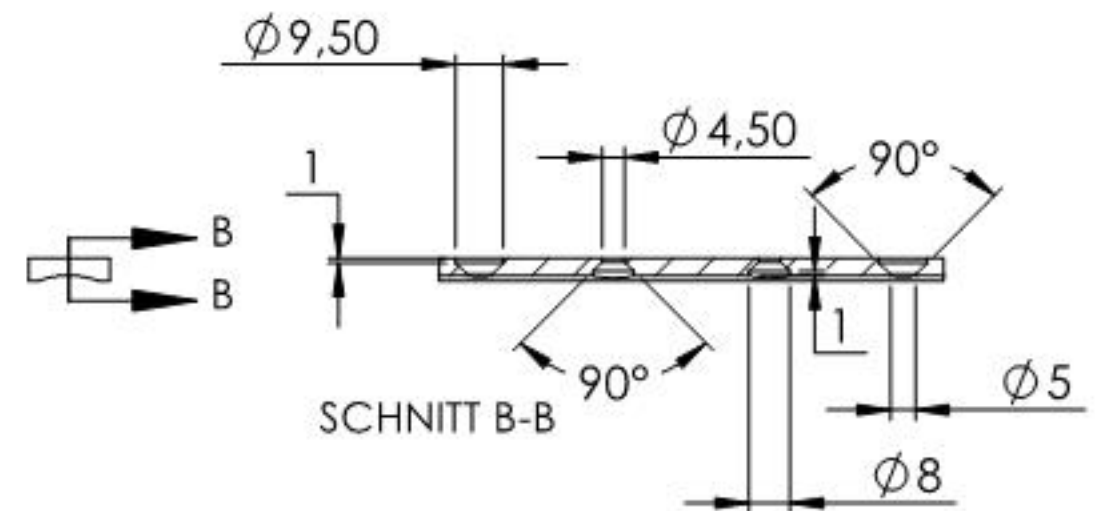

Name	Signatur	Datum	Artikelnummer	Oberfläche: Geschliffen Kam 240
Ch. Hölfig	CH	15.01.2024	70212-240 Teil1	
Werkstoff: 1.4301 (X5CrNi18-10)				Blattformat A4
Gewicht: 0,046 kg		Maßstab: 1:2	Version: 1	Deutsch
Blatt 2 von 6				

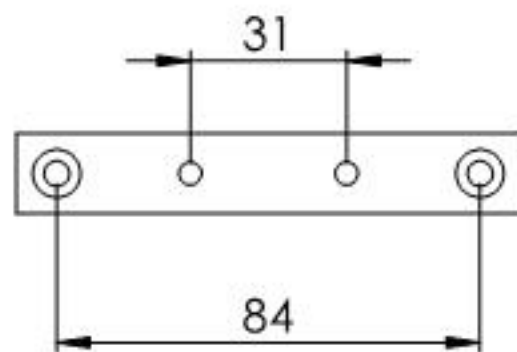
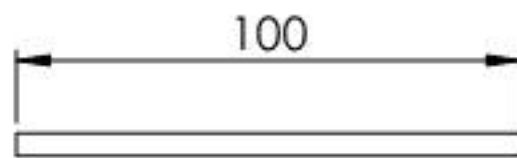
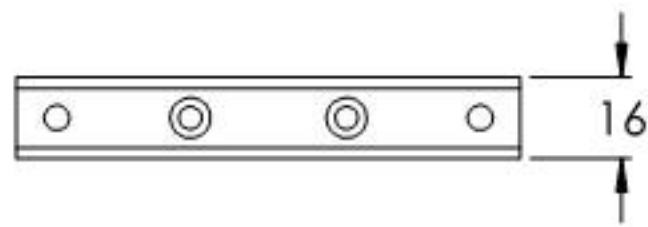
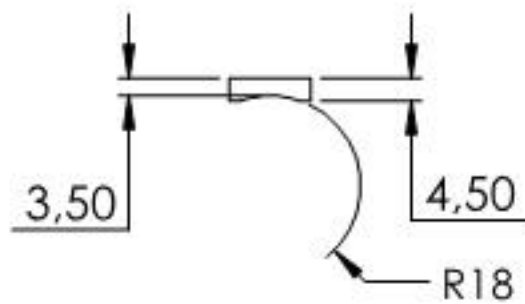
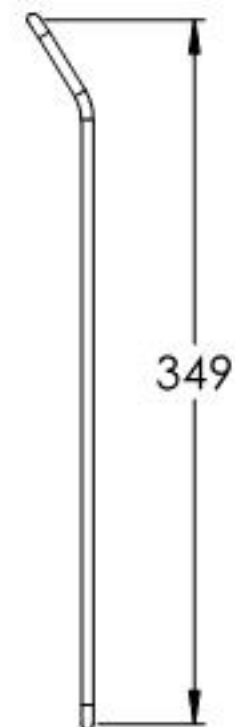
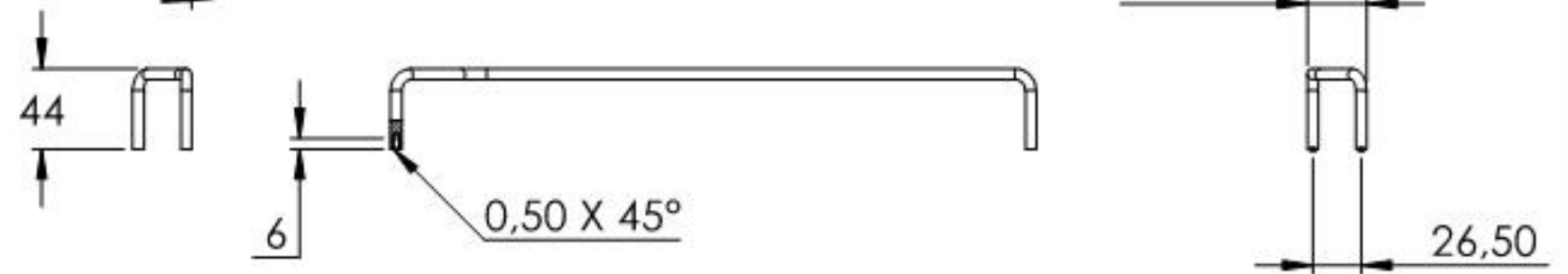
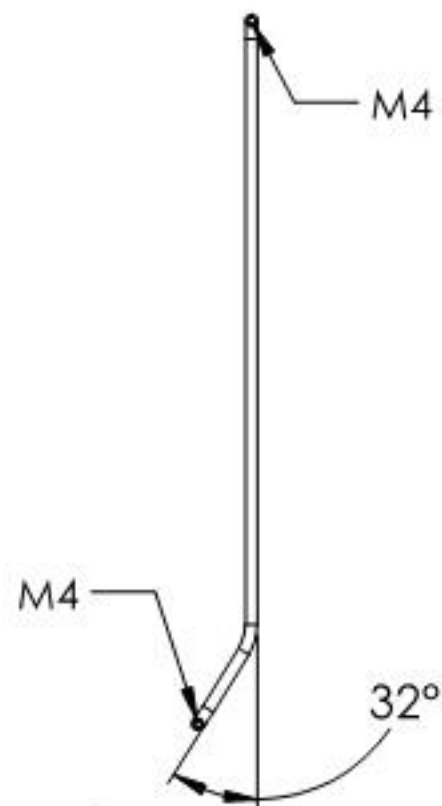
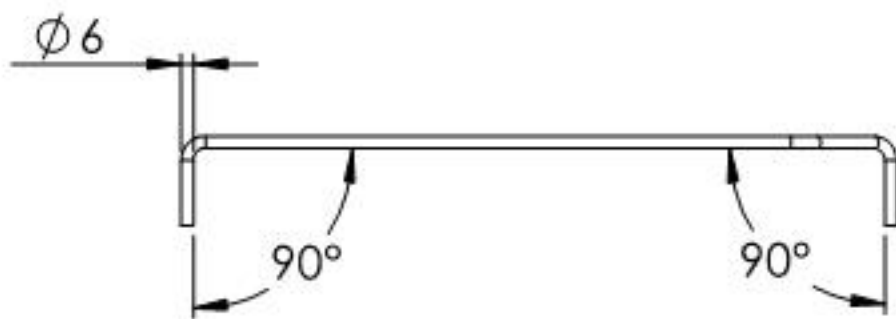

Name	Signatur	Datum	Artikelnummer	Oberfläche: Geschliffen Korn 240
Ch. Hölgl	CH	15.01.2024	70212-240 Teil2	
Werkstoff:				Blattformat
I.4301 (X5CrNi18-10)				A4
Gewicht: 0.095 kg		Maßstab: 1:5	Version: 1	Deutsch
Blatt 3 von 6				