

SCHNITT A-A

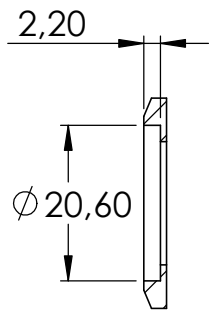

SCHNITT B-B

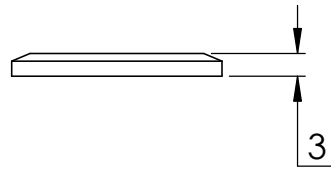
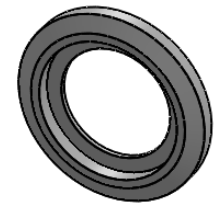
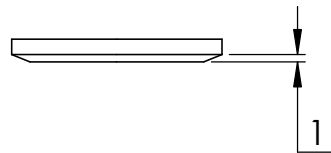
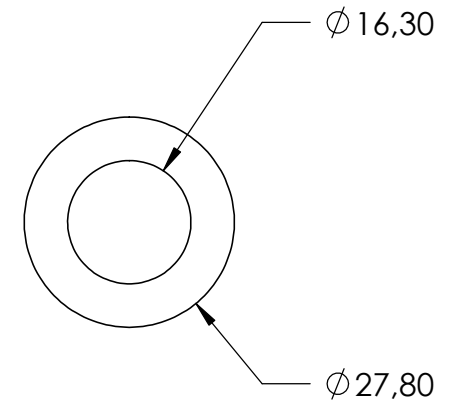
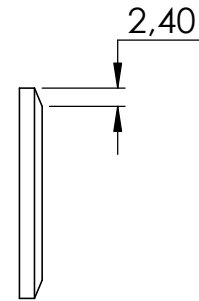
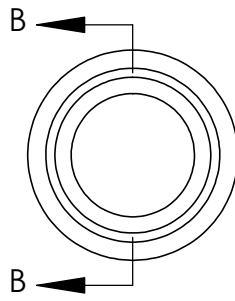

SCHNITT C-C

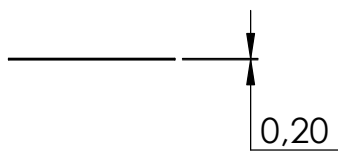
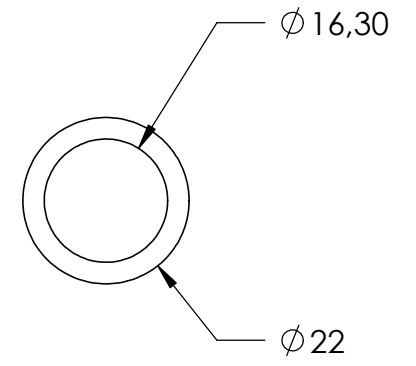
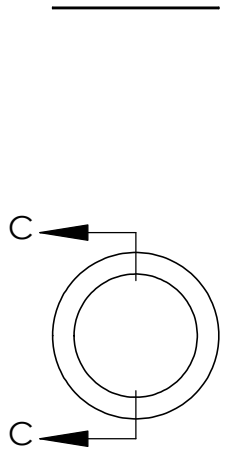

SCHNITT D-D

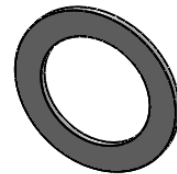
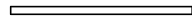
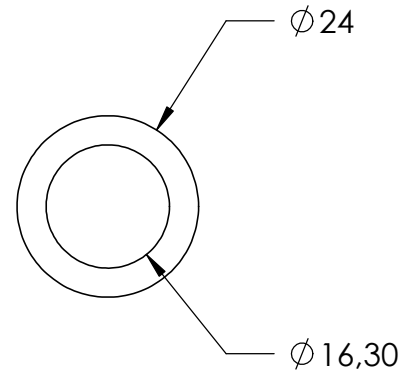
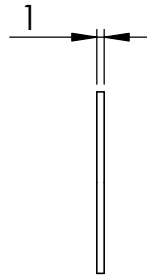
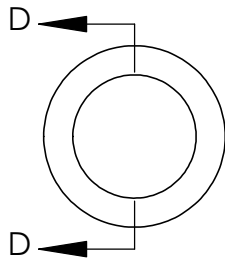

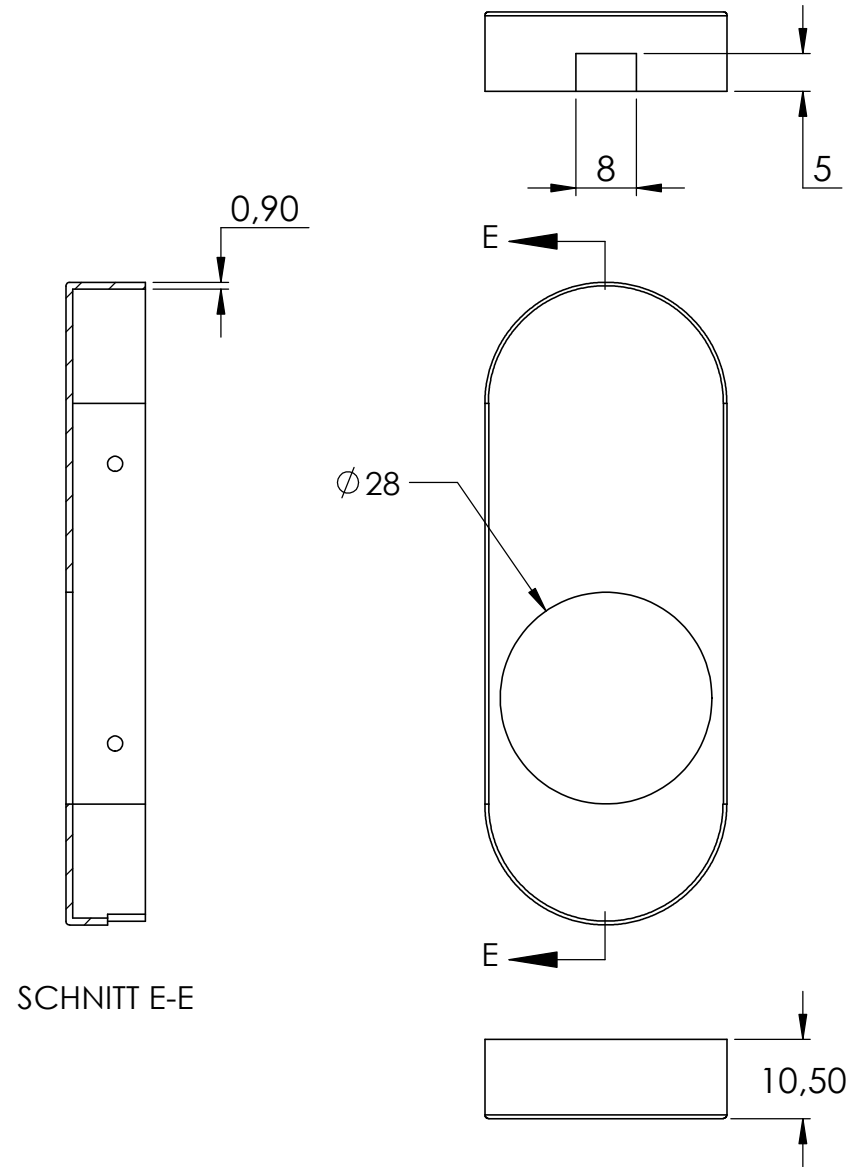

SCHNITT E-E

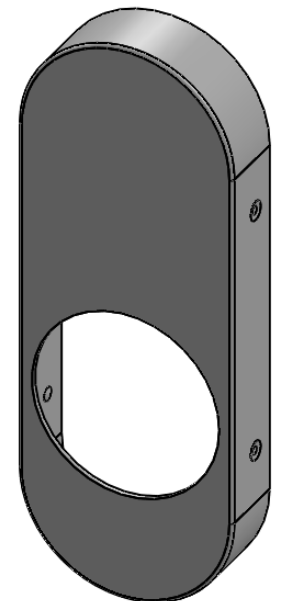
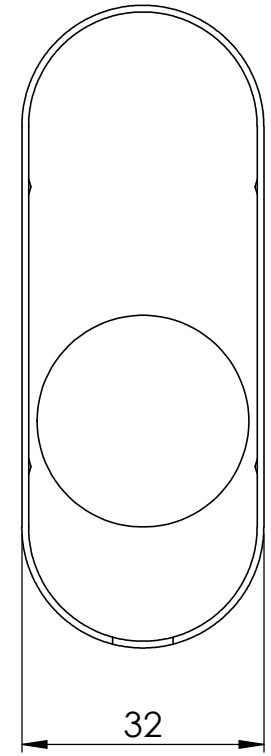
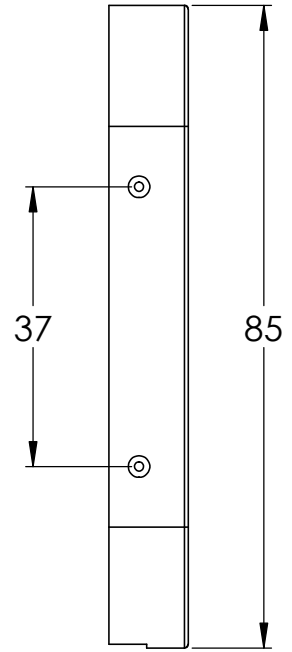

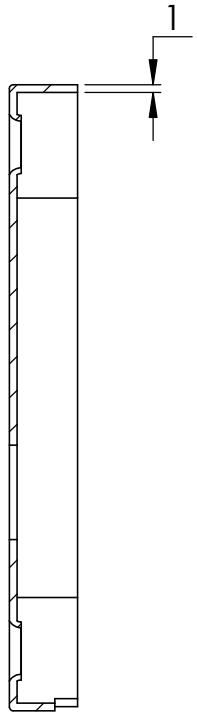
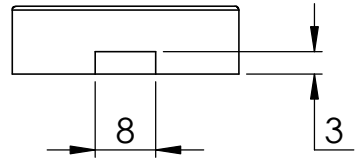

SCHNITT F-F

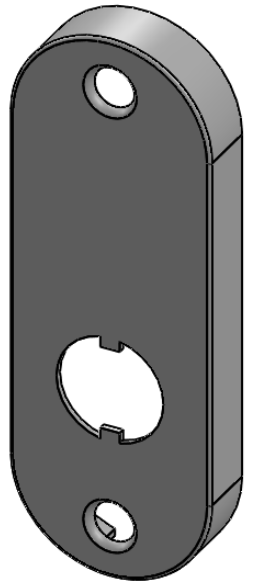
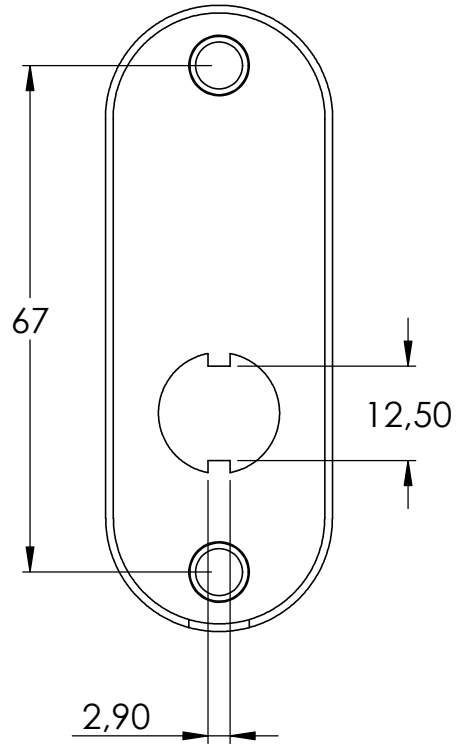
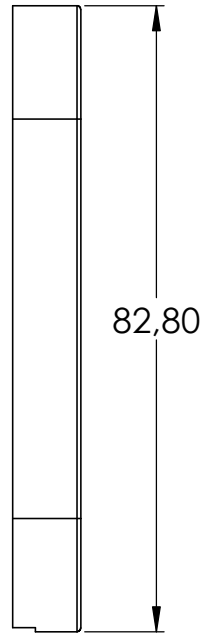
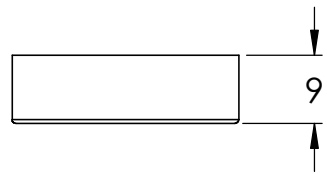
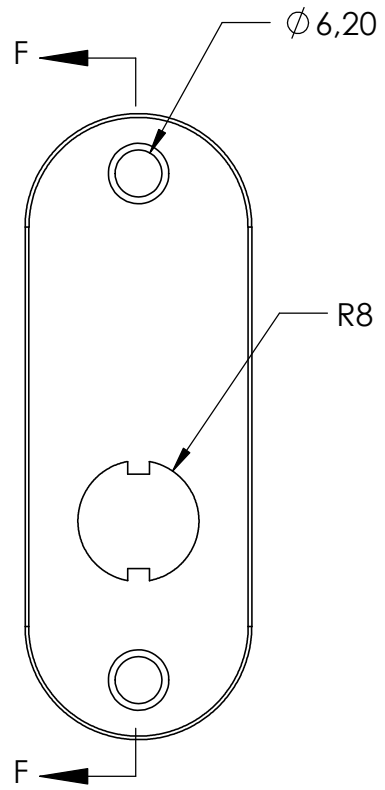

4	612-VA-F Teil2	1
5	612-VA-F Teil3	1
6	612-VA-F Teil4	1
7	612-VA-F Teil5	1
8	612-VA-F Teil1	1

