

Name	Signatur	Datum	Artikelnummer	Oberfläche: Geschliffen Korn 240
Ch. Höfig	CH	21.04.2021	041-HN-1	
Werkstoff: 1.4301 (X5CrNi18-10)				Blattformat A4
Gewicht 0.596 kg		Massstab: 1:5	Version: 1	Blatt 1 von 6

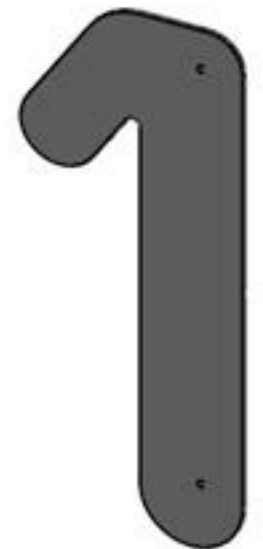

Name	Signatur	Datum	Artikelnummer	Oberfläche: Geschliffen Korn 240
Ch. Höfig	CH	21.04.2021	041-HN-1 Teil1	
Werkstoff:				Blattformat
1.4301 (X5CrNi18-10)				A4
Gewicht 0.335 kg		Maßstab: 1:5	Version: 1	Blatt 2 von 6

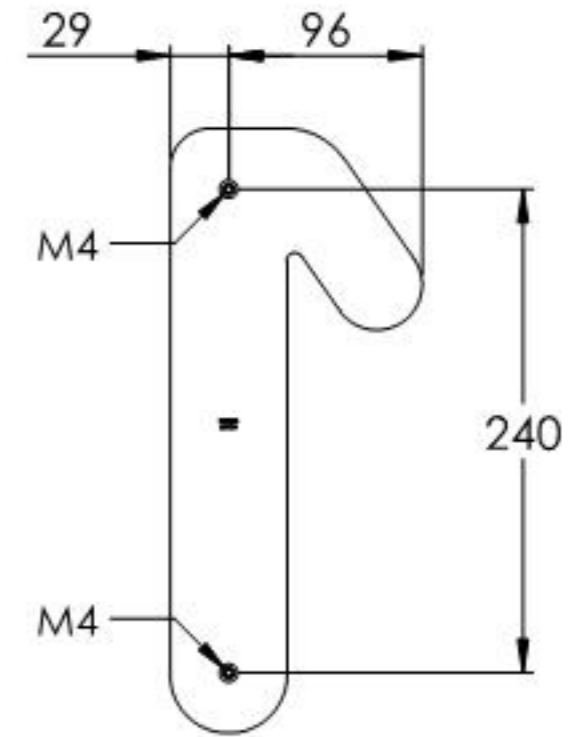
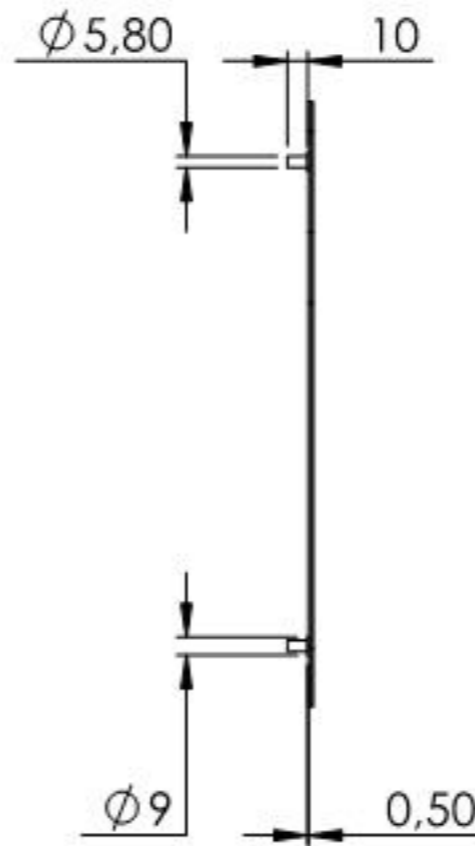
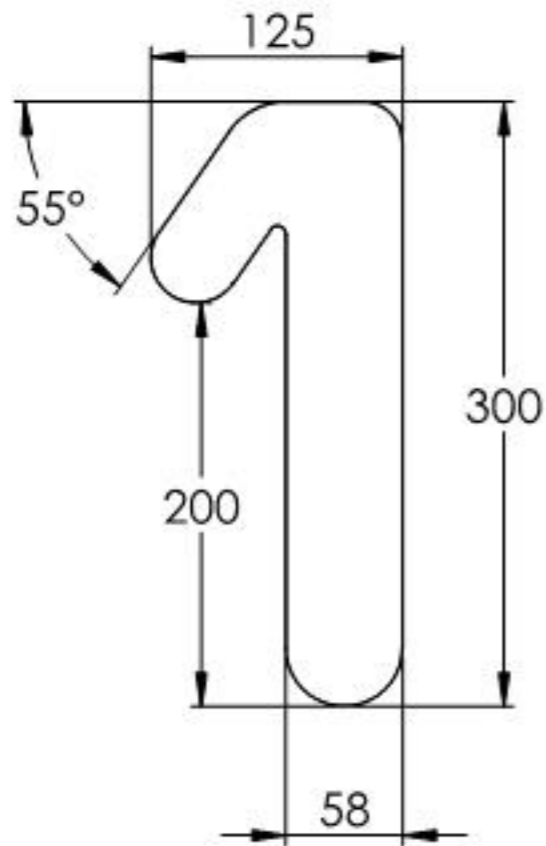
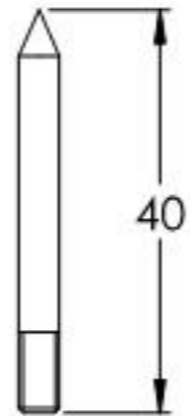
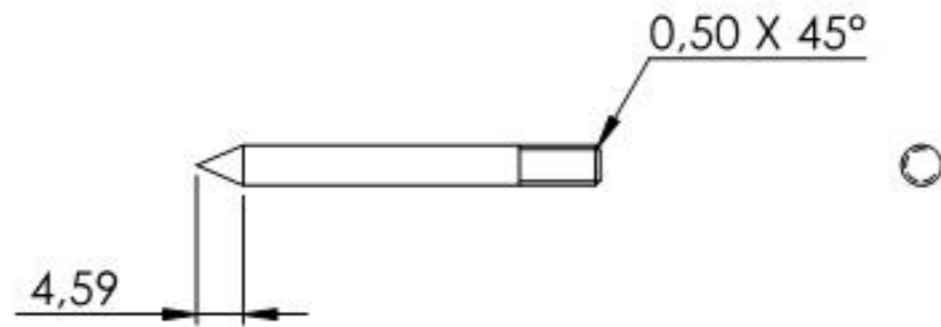
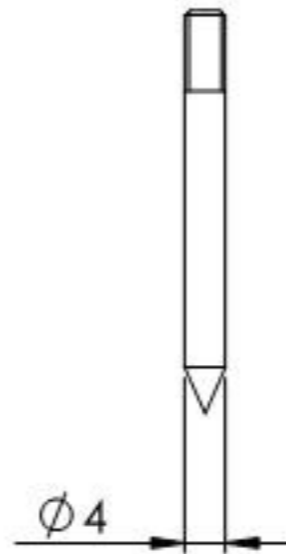
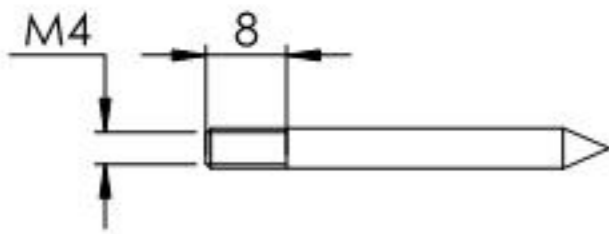

Name	Signatur	Datum	Artikelnummer	Oberfläche: Roh
Ch. Höfig	CH	21.04.2021	041-HN-X Teil2	
Werkstoff:				Blattformat
1.4301 (X5CrNi18-10)				A4
Gewicht 0.004 kg		Massstab: 1:1	Version: 1	Blatt 3 von 6