

SCHNITT A-A

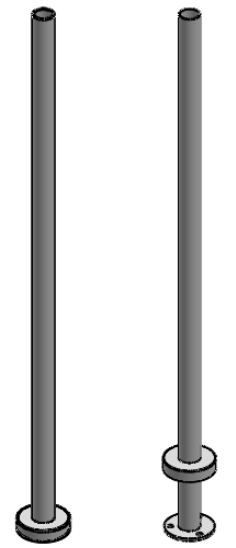

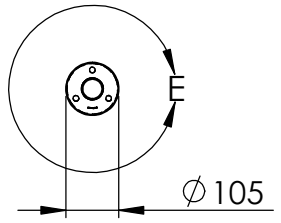

SCHNITT B-B

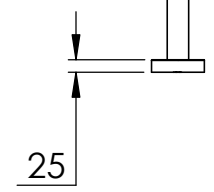
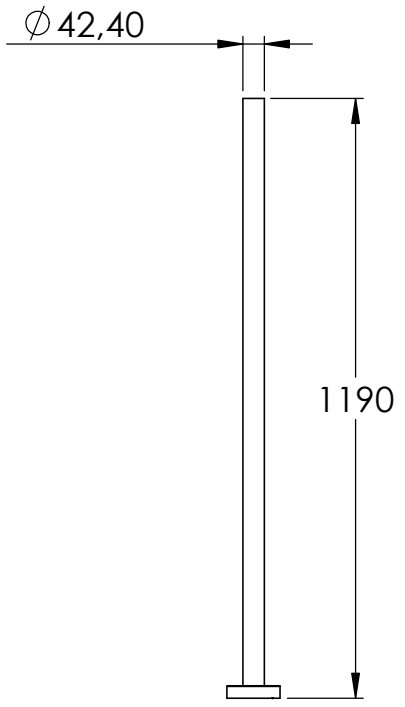
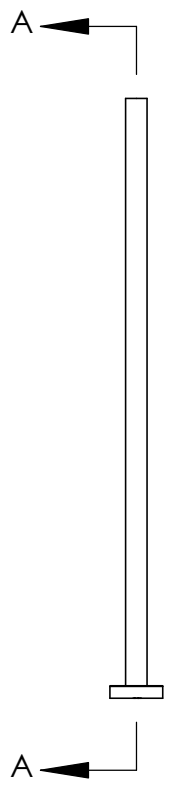
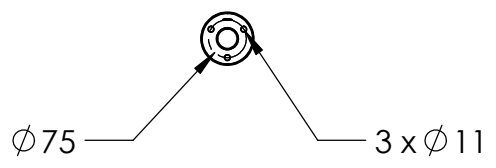
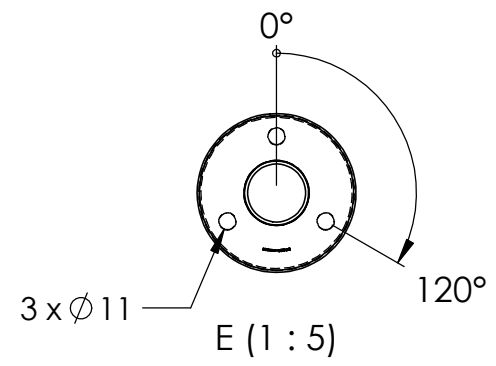
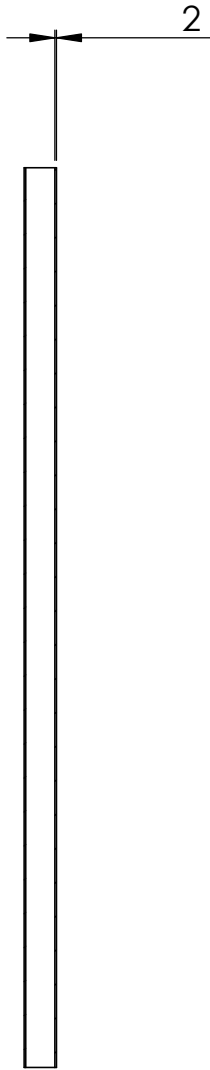
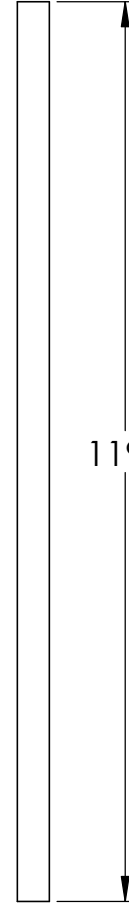
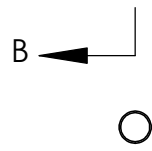
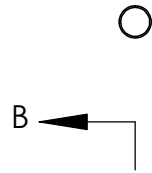

1190

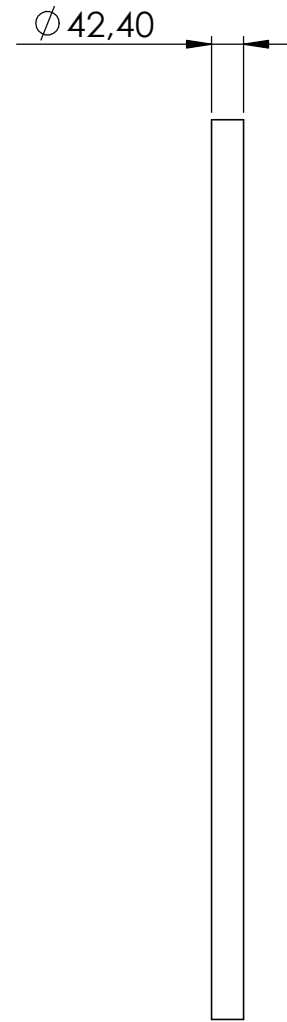

$\phi 42,40$



