

SCHNITT A-A

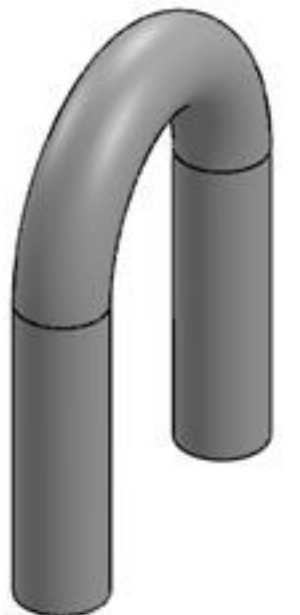
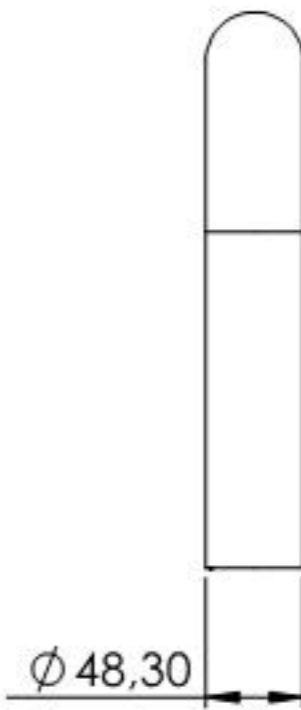
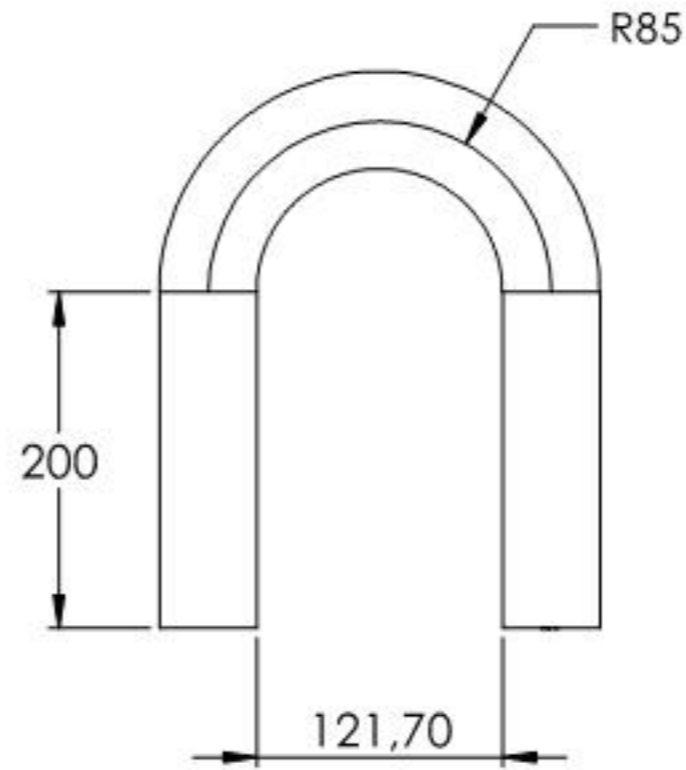
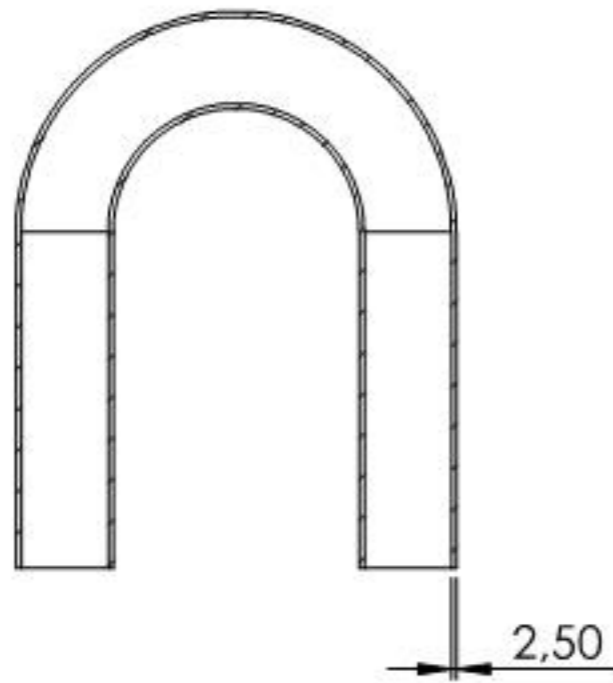

Name	Signatur	Datum	Artikelnummer	Oberfläche: ohne Nacharbeit	
Ch. Hölgl	CH	14.09.2023	6968-180		
Werkstoff:				Blattformat	
I.0037 (S235JR)				A4	
Gewicht: 1.683 kg		Maßstab: 1:5	Version: 1	Deutsch	Blatt 1 von 1