

SCHNITT A-A

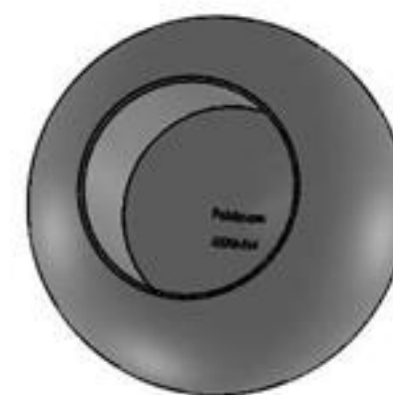
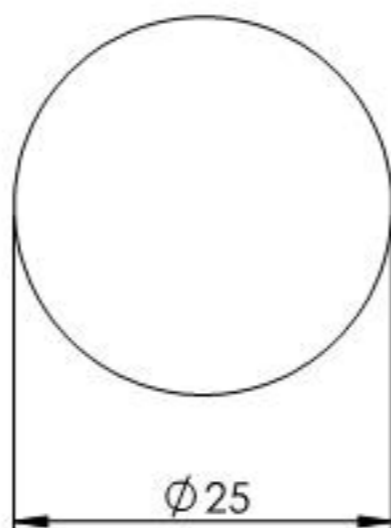
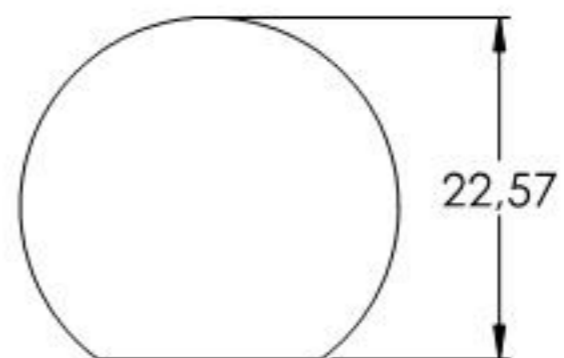
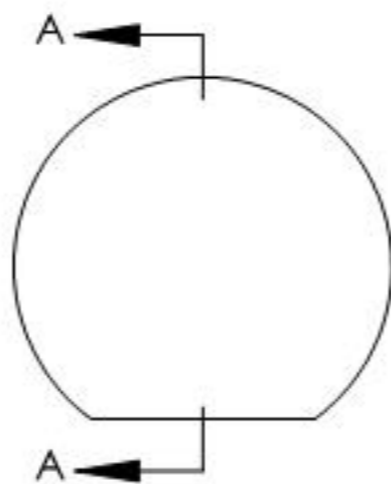
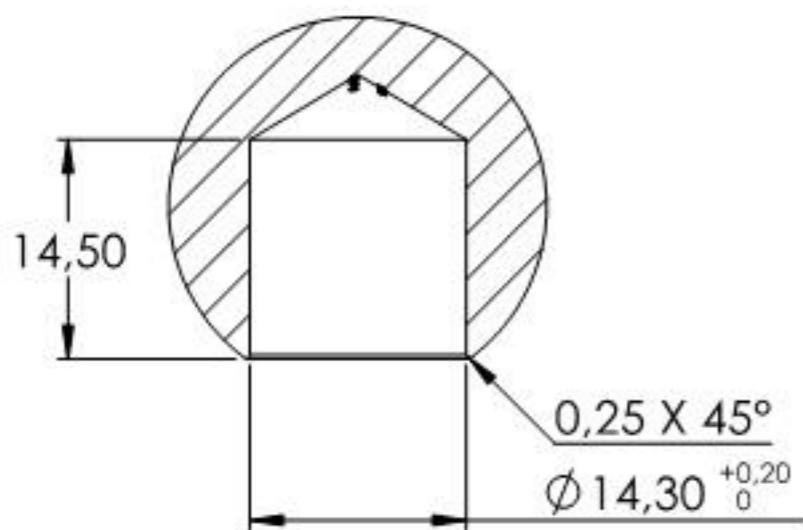

Name	Signatur	Datum	Artikelnummer	Oberfläche: Roh
Ch. Höfig	CH	03.02.2020	3572-S14	
Werkstoff:				Blattformat
1.0037 (S235JR)				A4
Gewicht 0,042 kg		Maßstab: 1,5:1	Version: 1,1	Blatt 1 von 1