

SCHNITT A-A

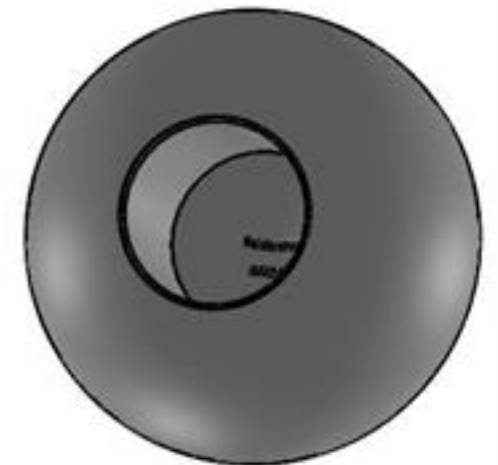
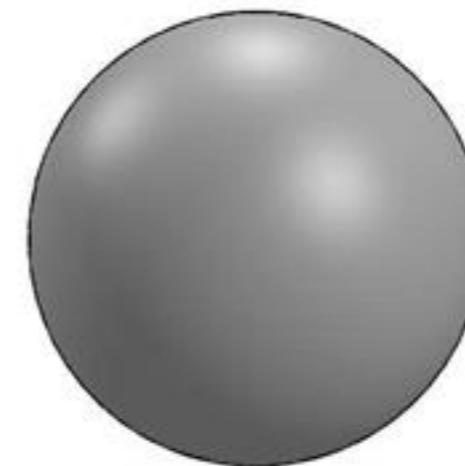
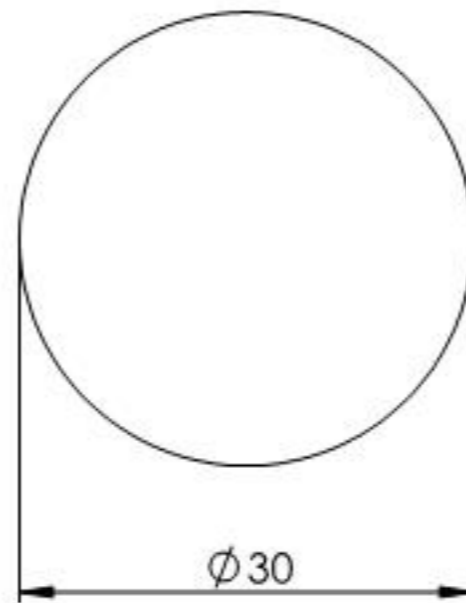
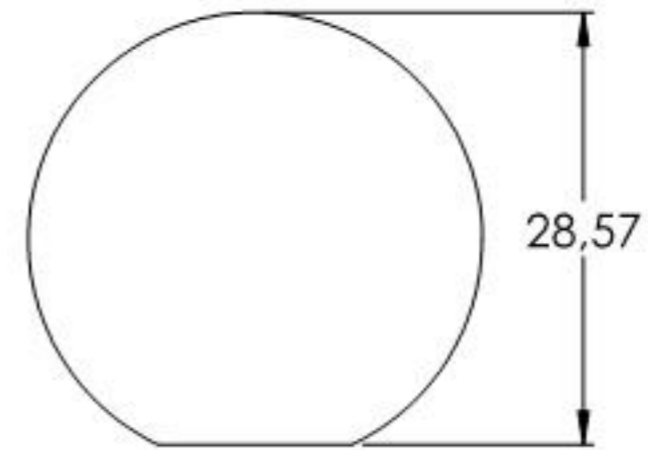
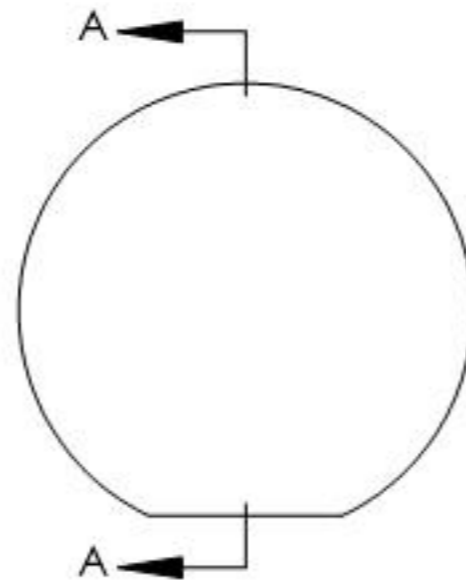
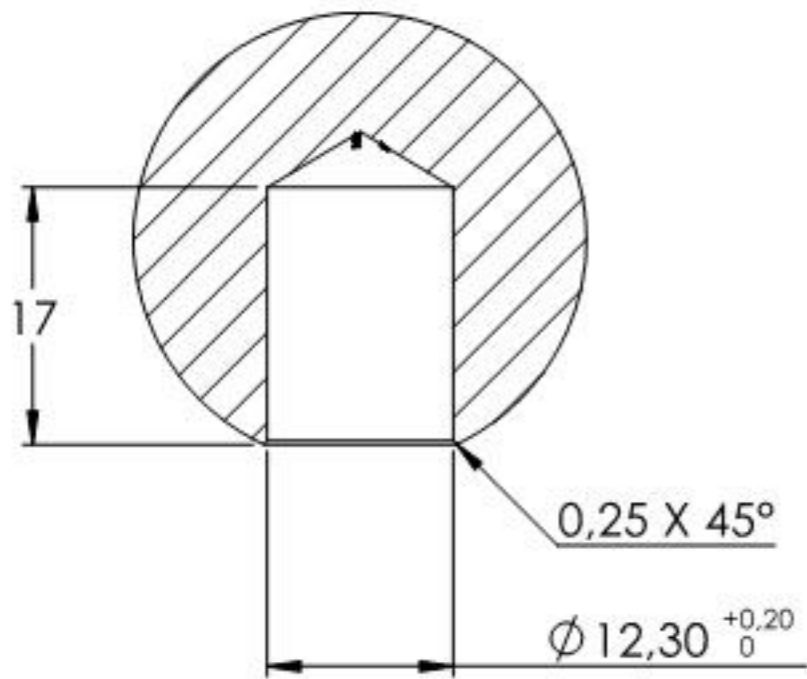

Name	Signatur	Datum	Artikelnummer	Oberfläche: Roh
Ch. Höfig	CH	03.02.2020	3573-S	
Werkstoff:				Blattformat
1.0037 (S235JR)				A4
Gewicht 0,093 kg		Maßstab: 1,5:1	Version: 1,2	Blatt 1 von 1