

Für Wandstärke 1,8 - 2,2mm

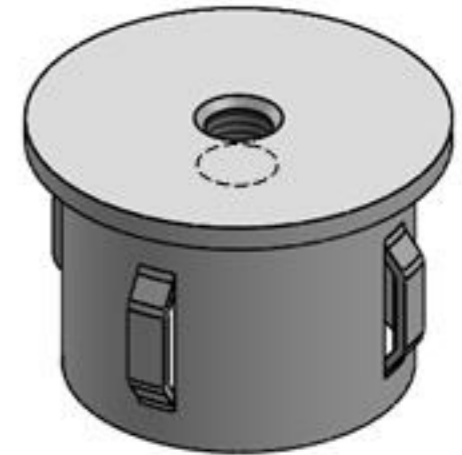
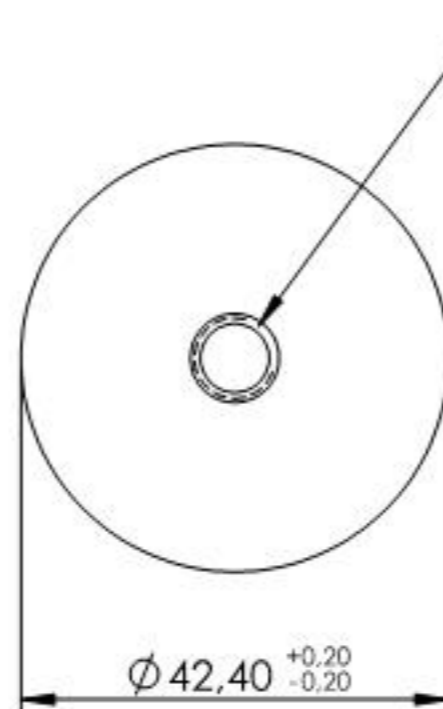
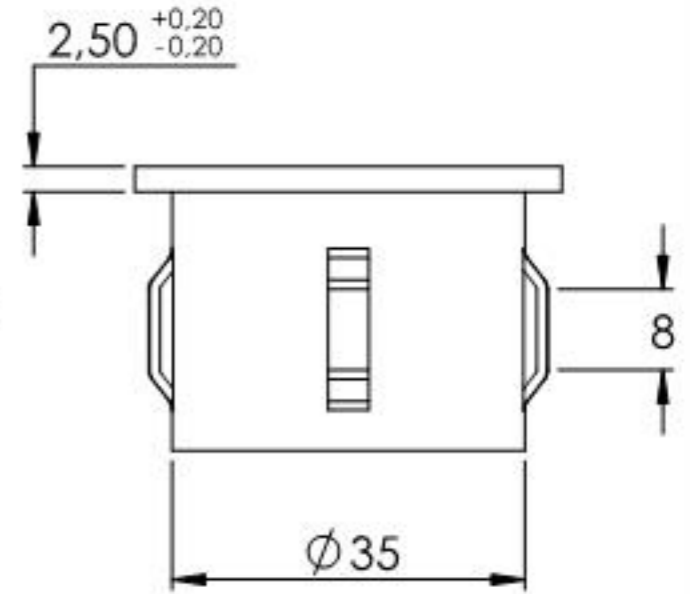
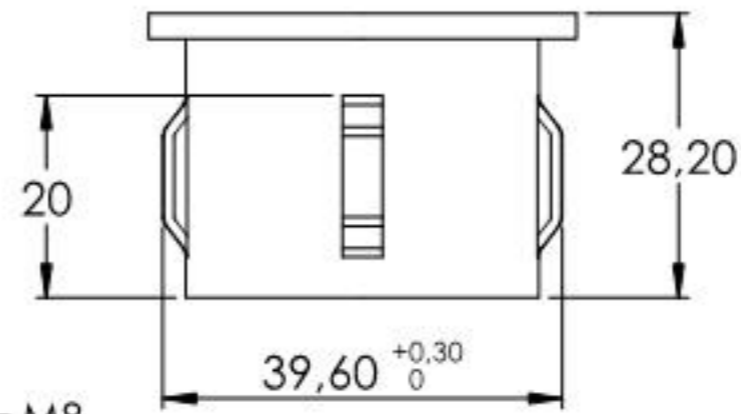
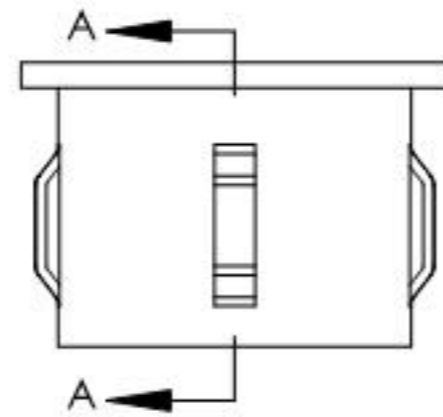
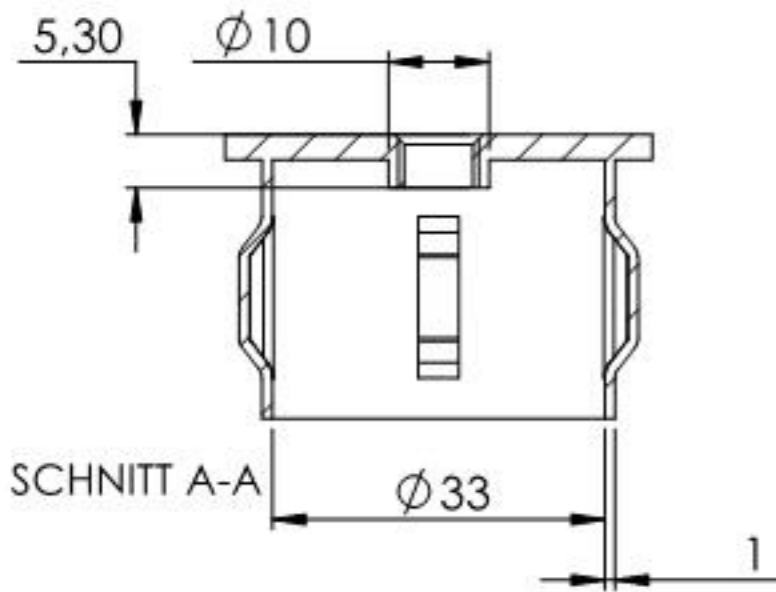

Name	Signatur	Datum	Artikelnummer	Oberfläche: Roh
Ch. Höfig	CH	16.09.2019	167-4200-M8	
Werkstoff:				Blattformat
1.0037 (S235JR)				A4
Gewicht 0,049 kg		Maßstab: 1:1	Version: 1	Blatt 1 von 1