

Name	Signatur	Datum	Artikelnummer	Oberfläche: Roh
Ch. Höfig	CH	20.09.2016	14407	
Werkstoff:				Blattformat
1.0037 (S235JR)				A4
Gewicht 1,626 kg		Maßstab: 1:2,5		Blatt 1 von 5

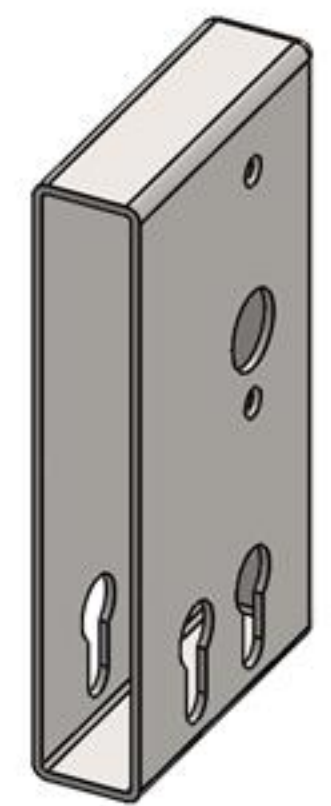

Name	Signatur	Datum	Artikelnummer	Oberfläche: Roh
Ch. Höfig	CH	20.09.2016	14407 Teil1	
Werkstoff:				Blattformat
1.0037 (S235JR)				A4
Gewicht 0,970 kg		Maßstab: 1:2,5		Blatt 2 von 5

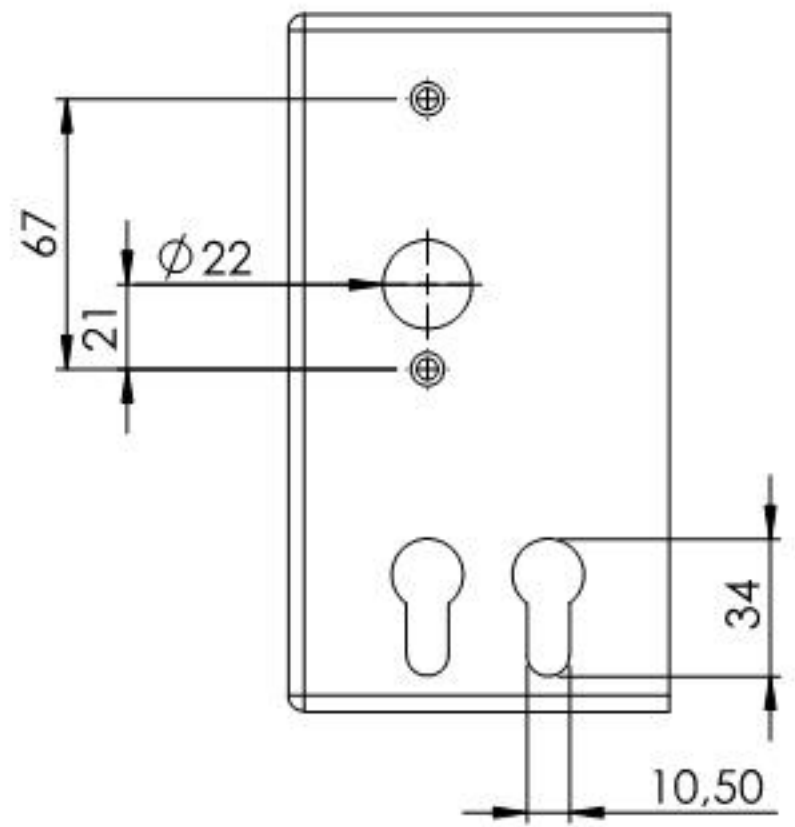
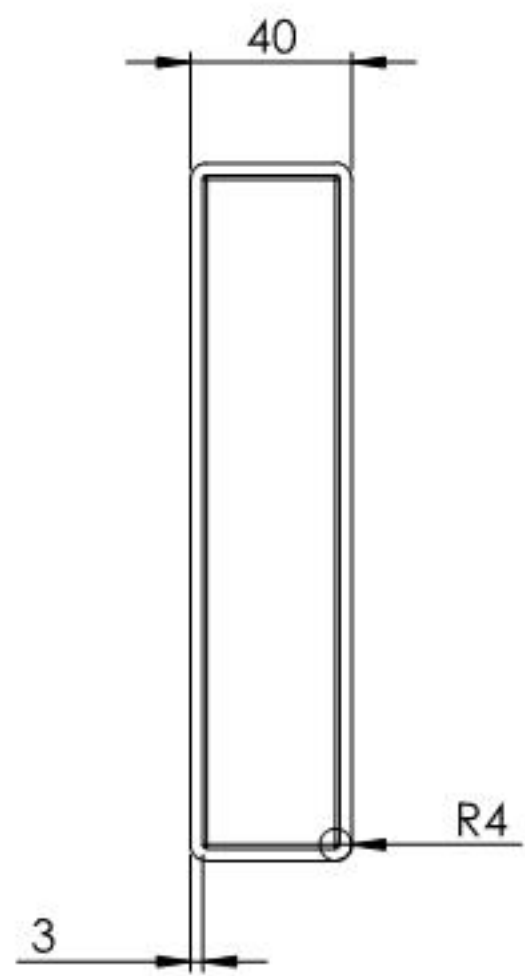
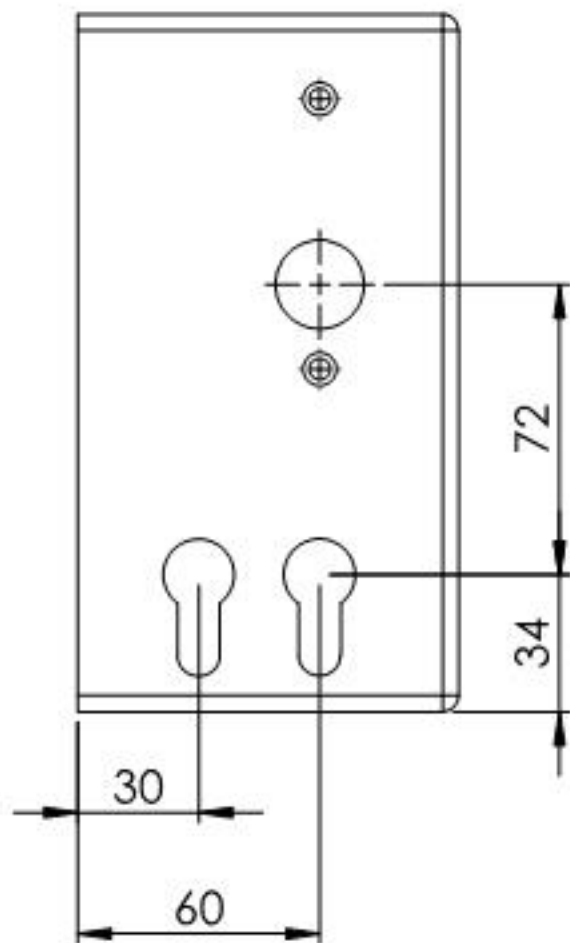
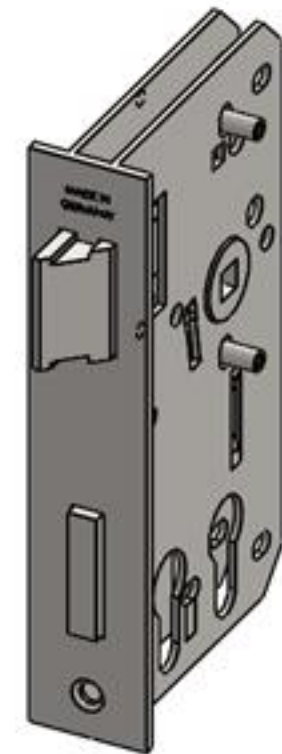
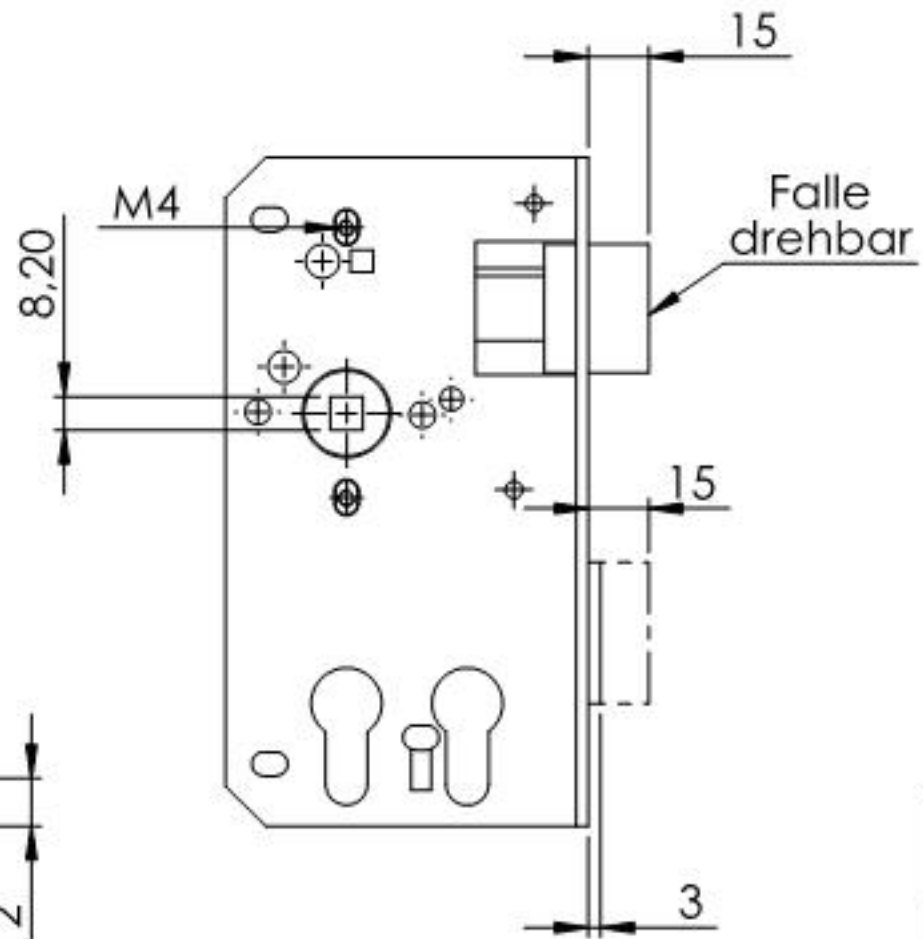
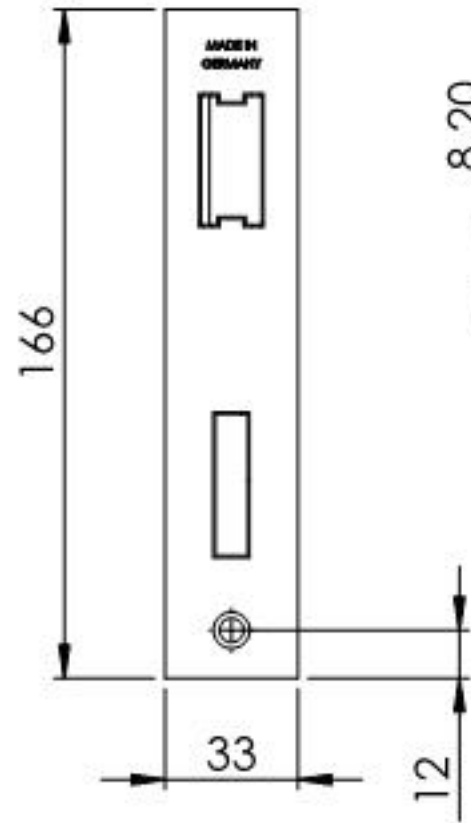
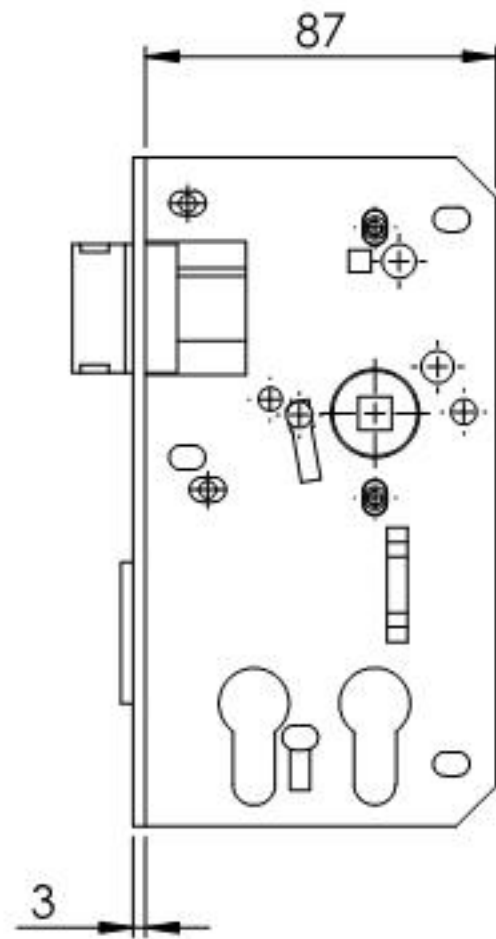

Name	Signatur	Datum	Artikelnummer	Oberfläche: Roh
Ch. Höfig	CH	20.09.2016	14407 Teil2	
Werkstoff:				Blattformat
1.0037 (S235JR)				A4
Gewicht 0.654 kg		Maßstab: 1:2.5		Blatt 3 von 5