

SCHNITT A-A

2x DIN 965 M4x8 Edelstahlschrauben
(Kreuzschlitz Z) inklusive

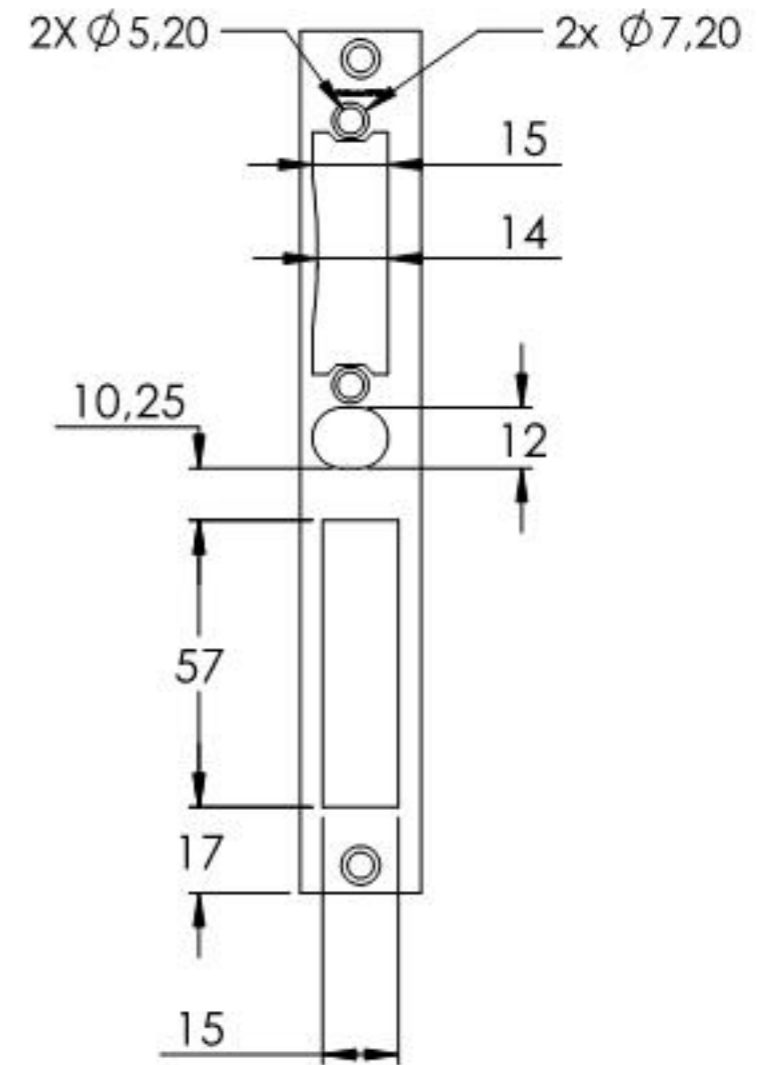

Name	Signatur	Datum	Artikelnummer	Oberfläche: Galvanisch verzinkt
Ch. Höfig	CH	07.10.2021	157628	
Werkstoff: 1.0037 (S235JR)				Blattformat A4
Gewicht 0.054 kg		Maßstab: 1:2	Version: 1	Blatt 1 von 1