

Es können Produktionsbedingte Abweichungen vorkommen!

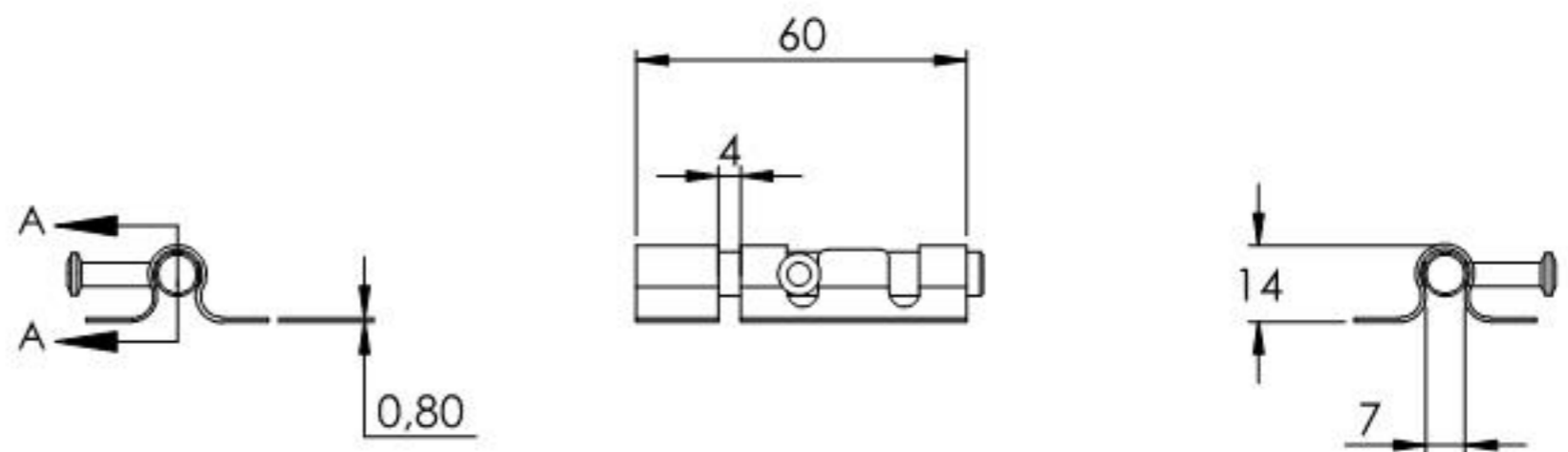

geöffnet

geschlossen

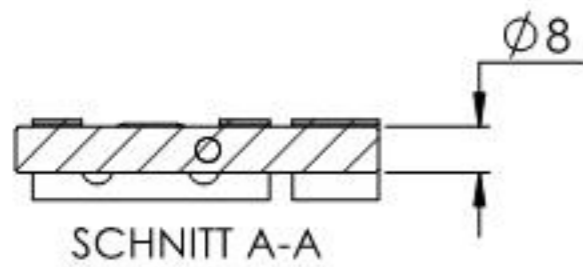
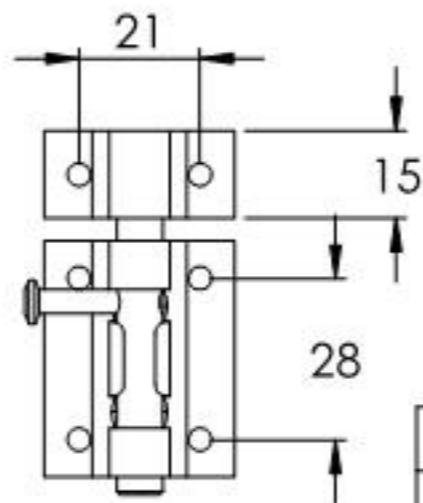
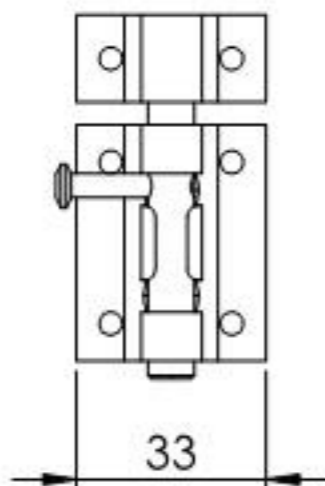
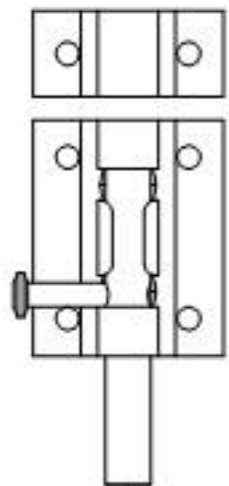

Name	Signatur	Datum	Artikelnummer	Oberfläche: Verzinkt
Ch. Häfig	CH	09.05.2023	700-60	
Werkstoff: 1.0037 (S235JR)				Blattformat A4
Gewicht 0.043 kg		Maßstab: 1:1,75 Version: 1		Blatt 1 von 1