

Name	Signatur	Datum	Artikelnummer	Oberfläche: Verzinkt
Ch. Höfig	CH	10.12.2020	68-A-500	
Werkstoff:				Blattformat
1.0037 (S235JR)				A4
Gewicht 0.734 kg		Maßstab: 1:7	Version: 1	Blatt 1 von 5

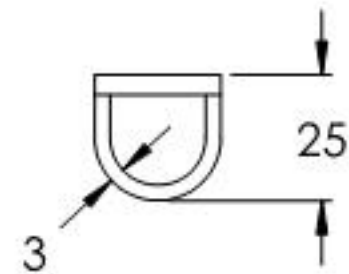

Name	Signatur	Datum	Artikelnummer	Oberfläche: Verinkt
Ch. Höfig	CH	10.12.2020	68-A-300 Teil1	
Werkstoff:				Blattformat
1.0037 (S235JR)				A4
Gewicht 0.206 kg		Maßstab: 1:2	Version: 1	Blatt 2 von 5

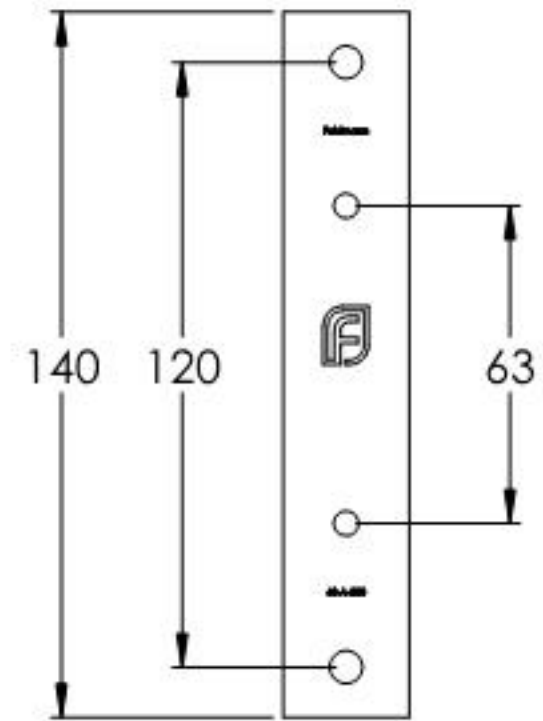
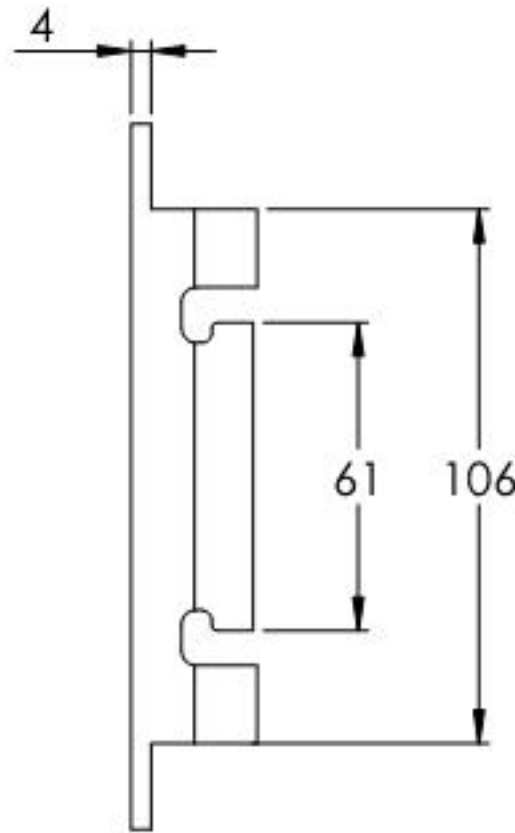
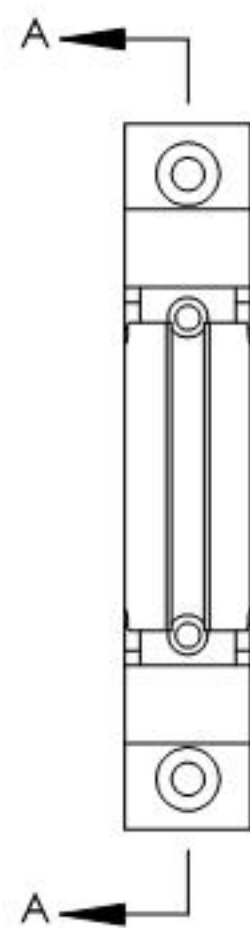
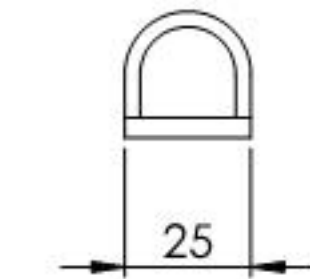
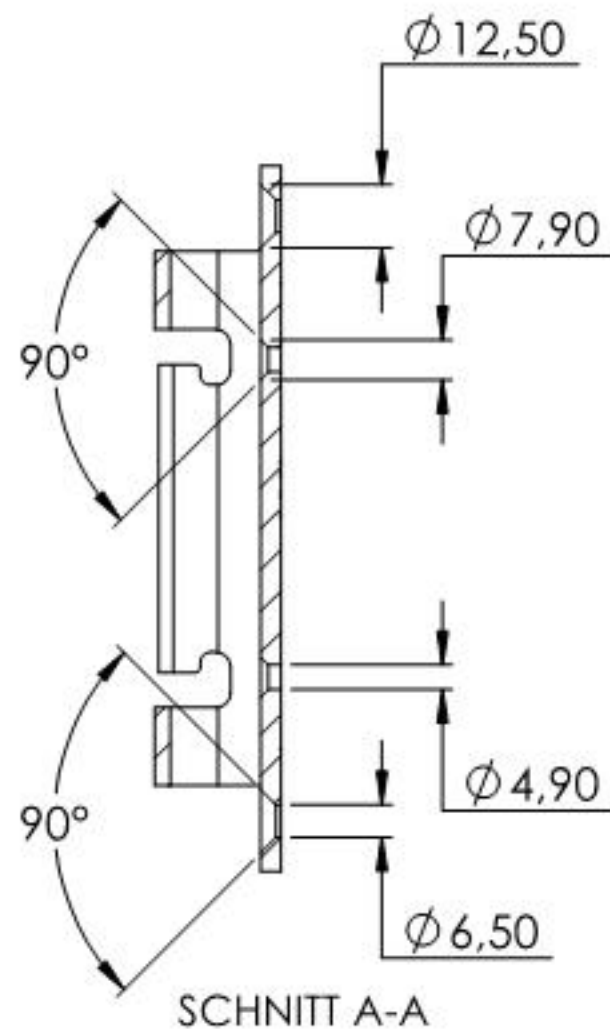
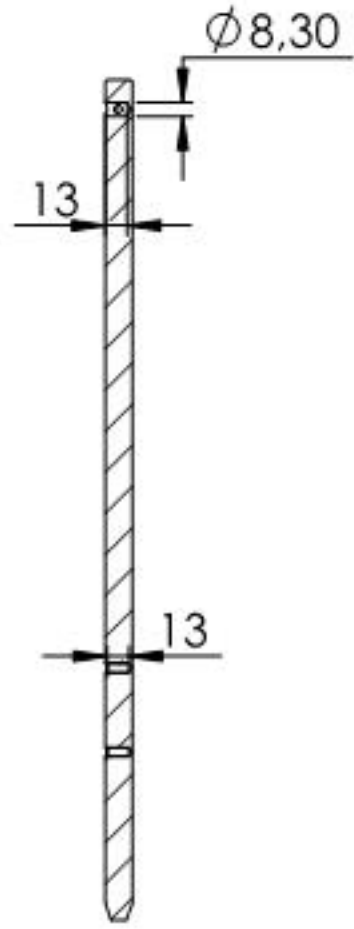

SCHNITT B-B

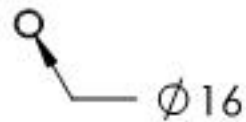
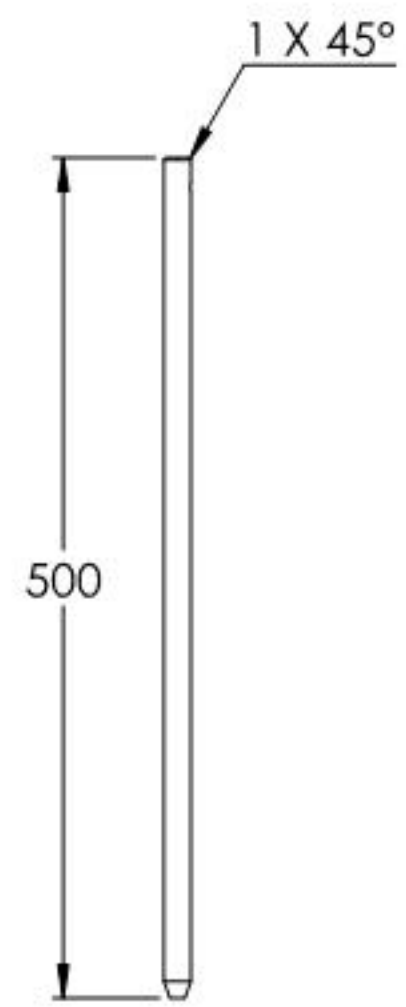
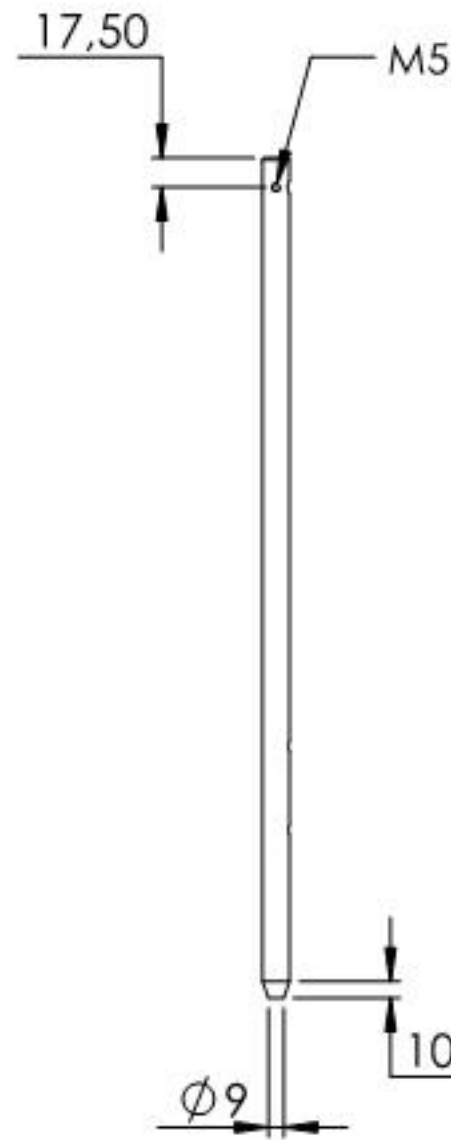
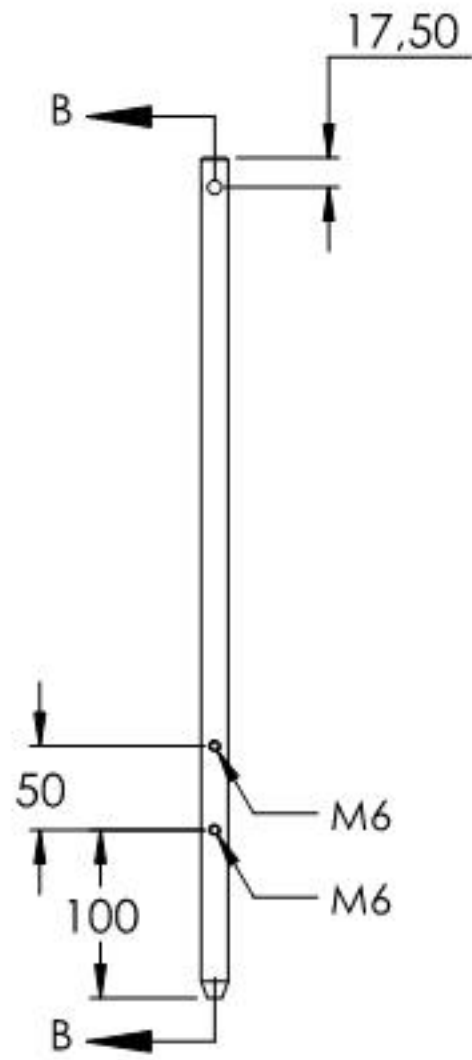

Name	Signatur	Datum	Artikelnummer	Oberfläche: Verzinkt
Ch. Höfig	CH	10.12.2020	68-A-500 Teil2	
Werkstoff:				Blattformat
1.0037 (S235JR)				A4
Gewicht 0.767 kg		Maßstab: 1:6	Version: 1	Blatt 3 von 5