

Tragkraft: 75kg
Gilt für 2 Bänder

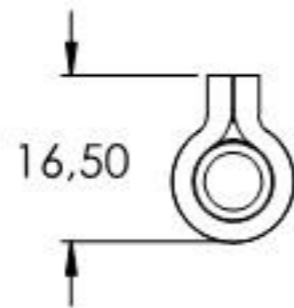

Name	Signatur	Datum	Artikelnummer	Oberfläche: Roh
Ch. Höfig	CH	06.09.2021	402-80	
Werkstoff: 1.0037 (S235JR)				Blattformat A4
Gewicht 0,092 kg		Maßstab: 1:1	Version: 1	Blatt 1 von 6

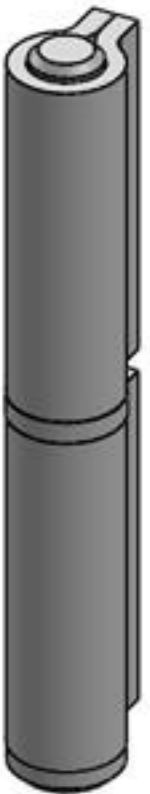
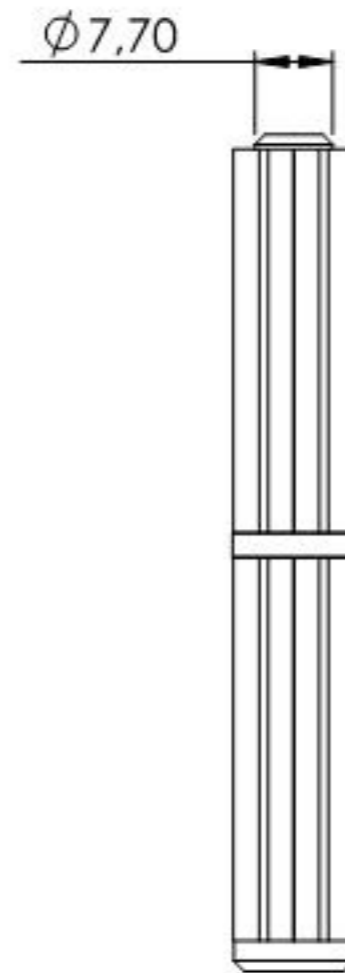
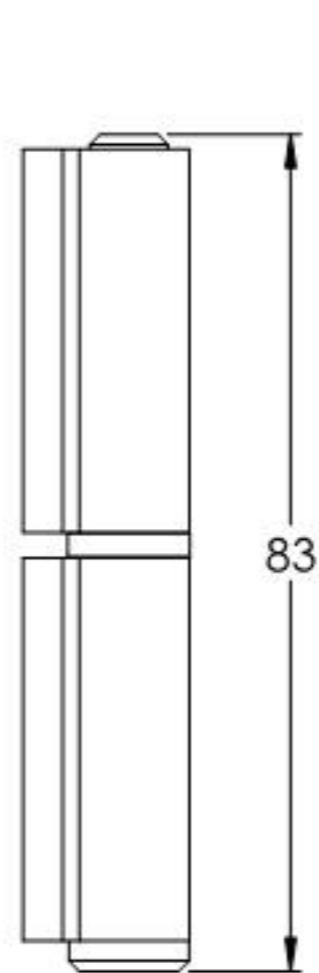
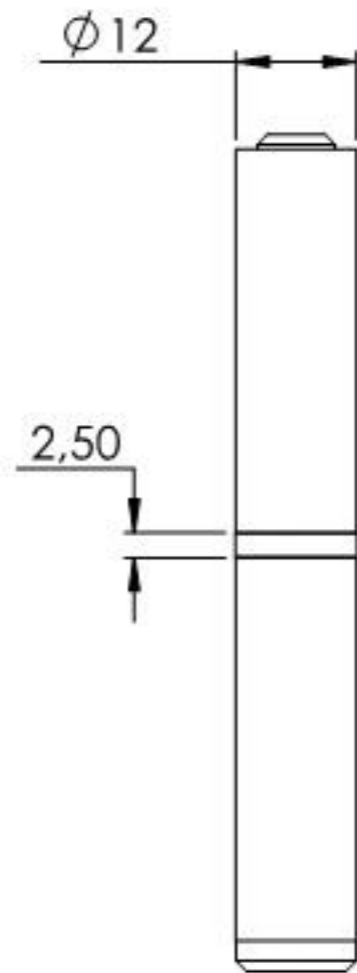
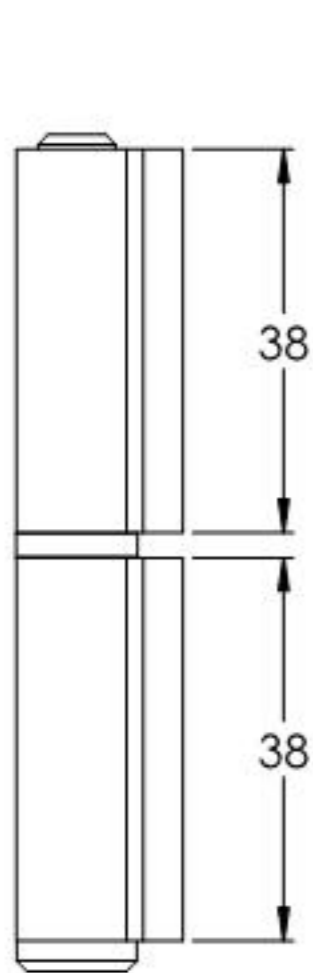
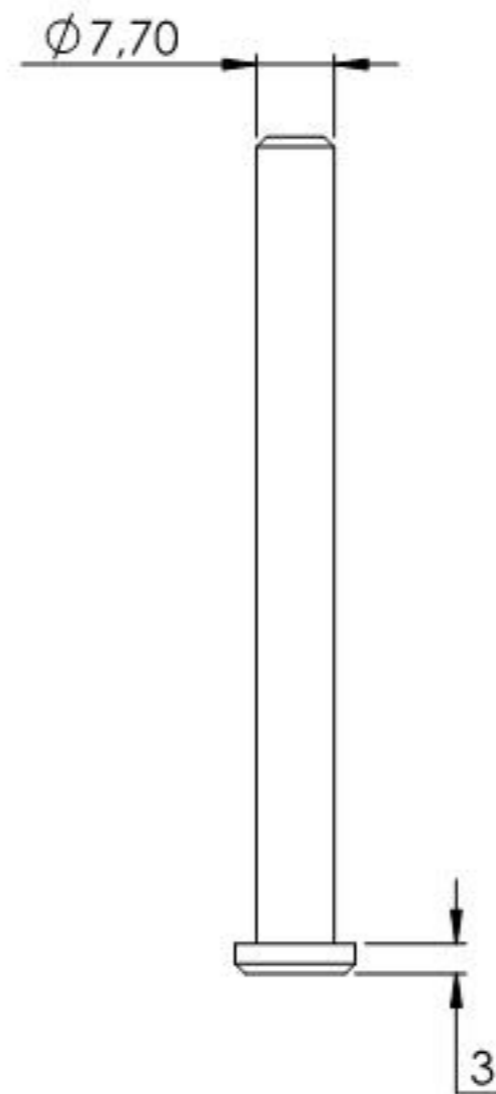
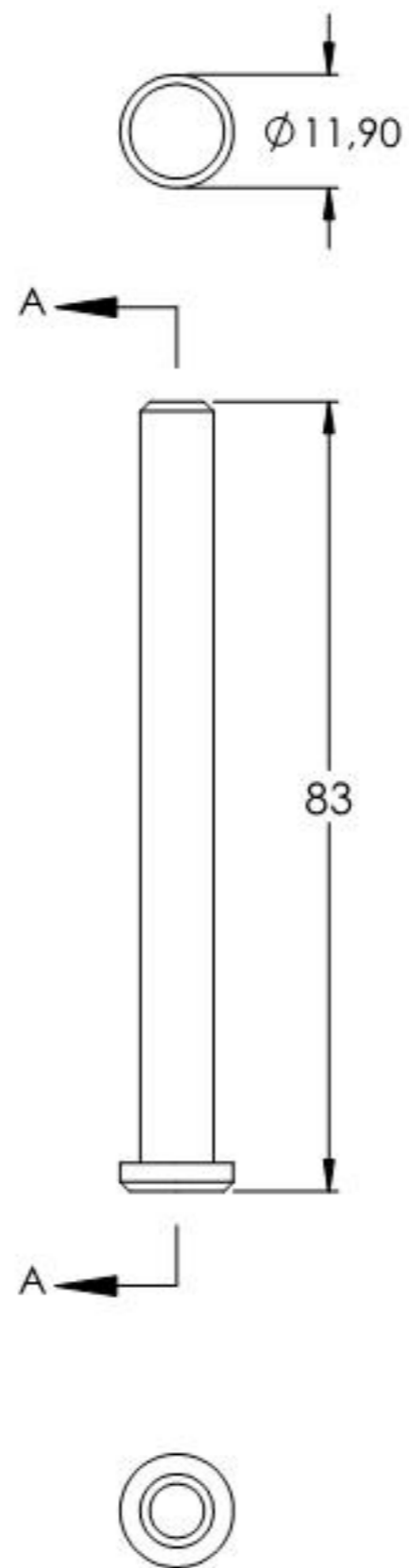
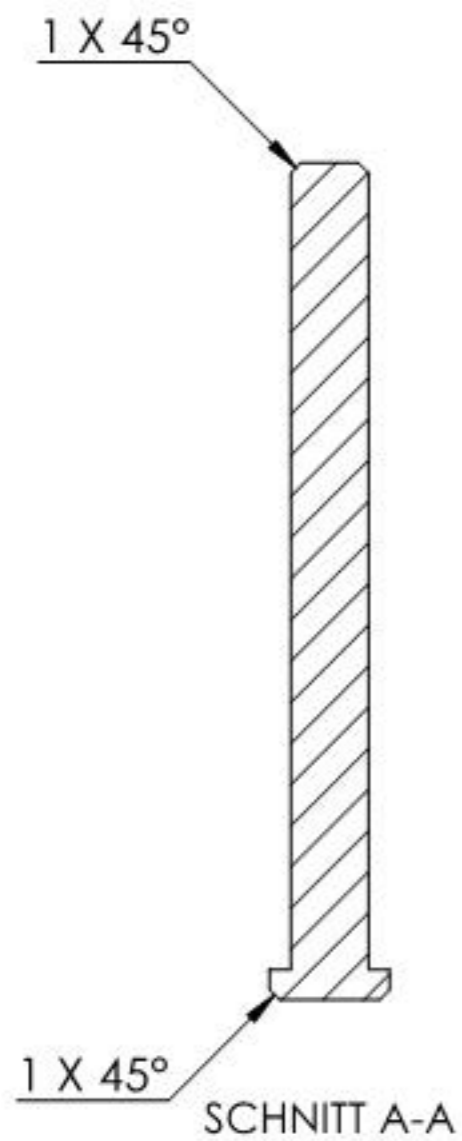

Name	Signatur	Datum	Artikelnummer	Oberfläche: Verzinkt
Ch. Höfig	CH	06.09.2021	402-80 Teil1	
Werkstoff:				Blattformat
1.0037 (S235JR)				A4
Gewicht 0.031 kg		Maßstab: 1:1	Version: 1	Blatt 2 von 6

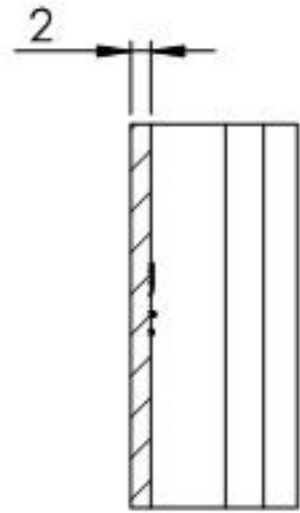
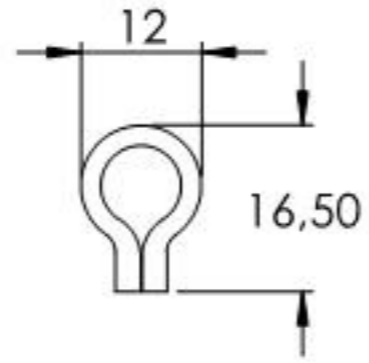

SCHNITT B-B

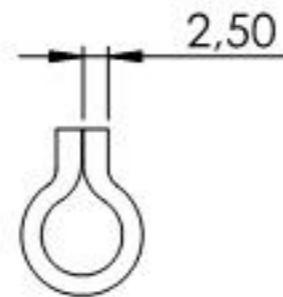
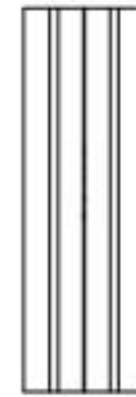
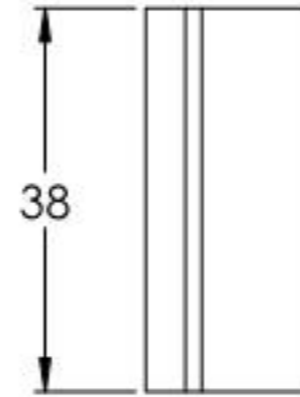

Name	Signatur	Datum	Artikelnummer	Oberfläche: Roh
Ch. Höfig	CH	06.09.2021	402-80 Teil2	
Werkstoff:				Blattformat
1.0037 (S235JR)				A4
Gewicht 0,025 kg		Maßstab: 1:1	Version: 1	Blatt 3 von 6