

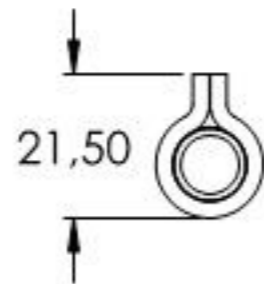

Tragkraft: 200kg
Gilt für 2 Bänder

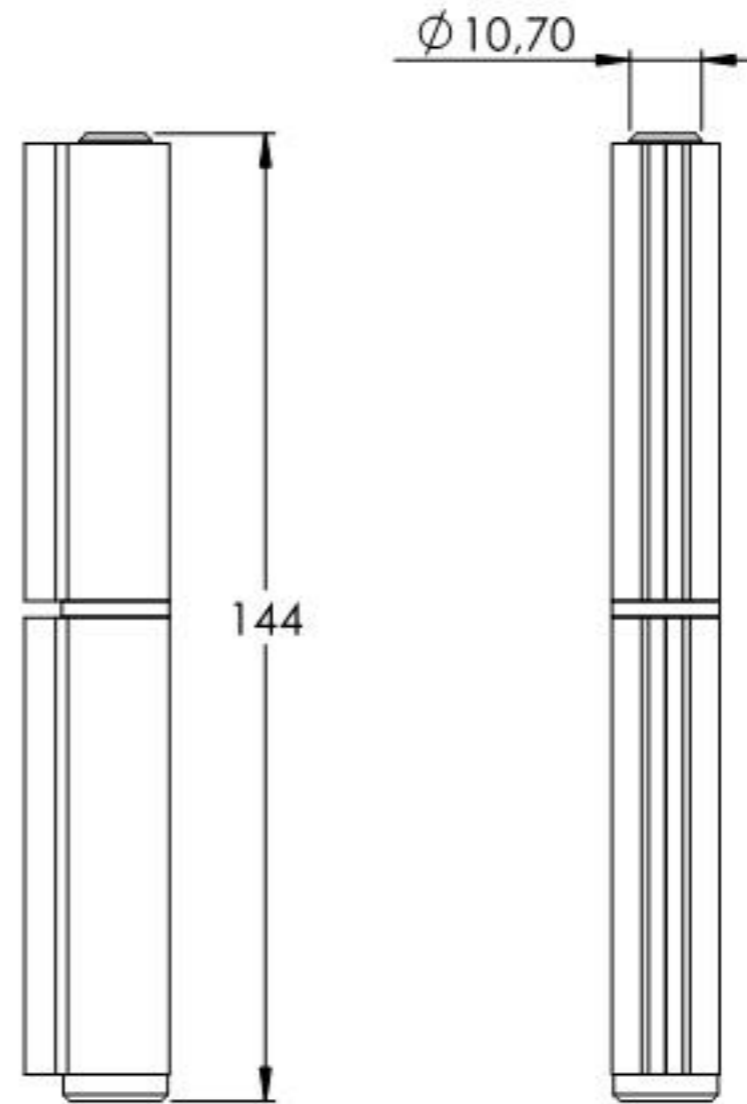

Name	Signatur	Datum	Artikelnummer	Oberfläche: Roh
Ch. Höfig	CH	06.09.2021	402-14	
Werkstoff: 1.0037 (S235JR)				Blattformat A4
Gewicht 0.245 kg		Massstab: 1:1,5	Version: 1	Blatt 1 von 6

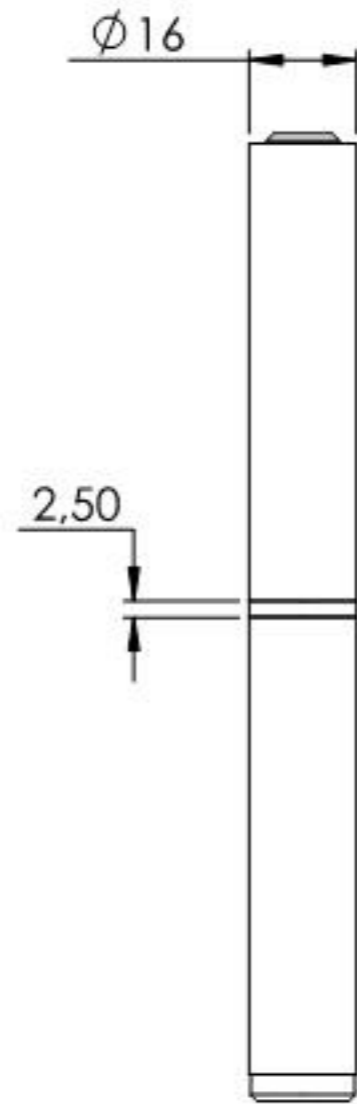
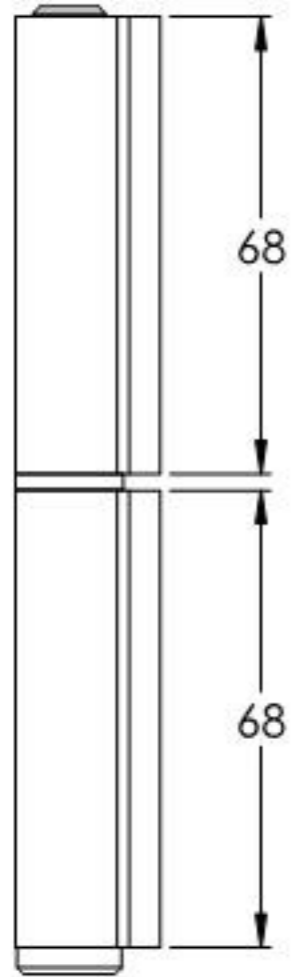
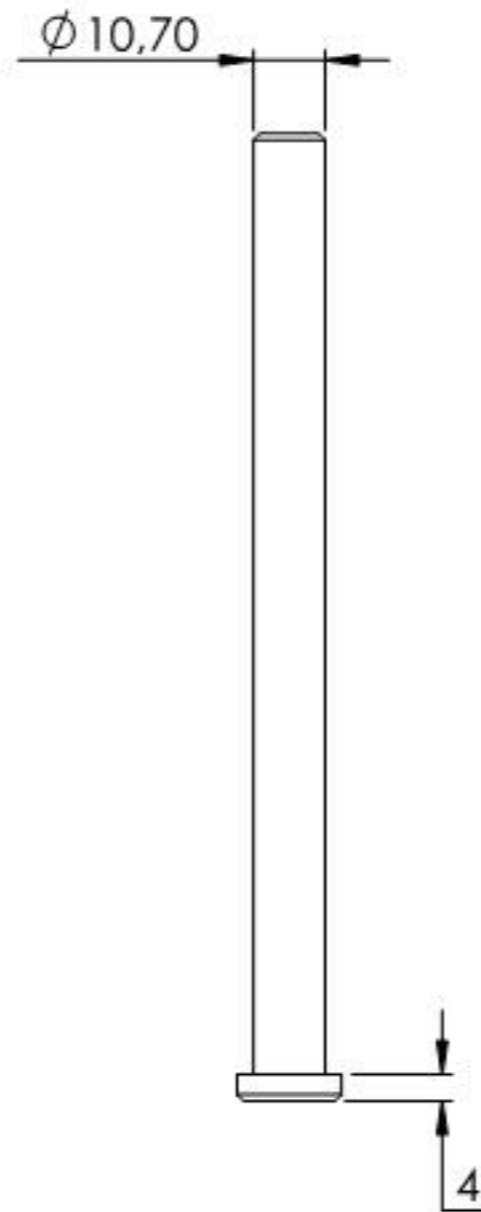
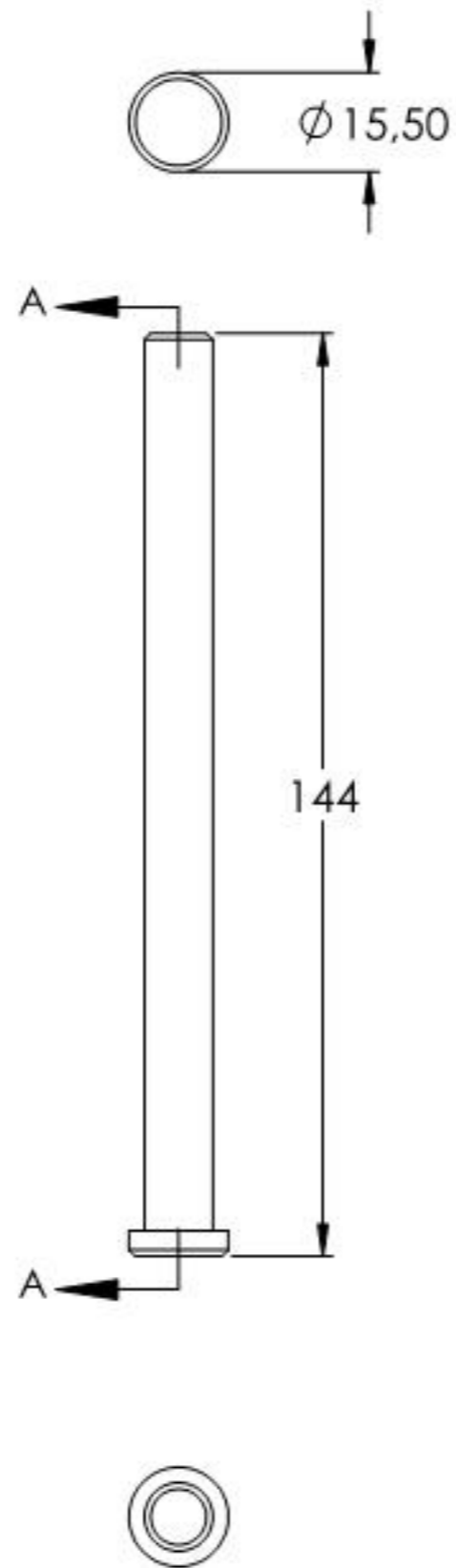
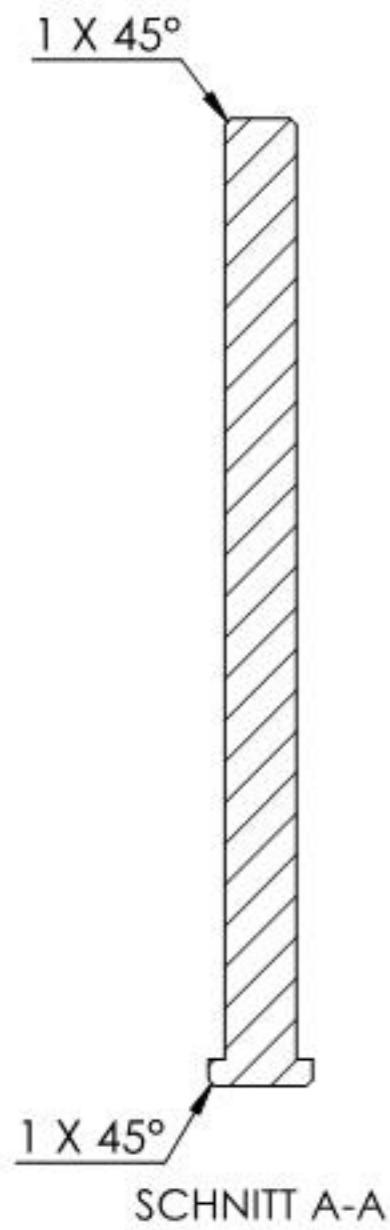

Name	Signatur	Datum	Artikelnummer	Oberfläche: Verzinkt
Ch. Höfig	CH	06.09.2021	402-14 Teil1	
Werkstoff:				Blattformat
1.0037 (S235JR)				A4
Gewicht 0.104 kg		Massstab: 1:1.5	Version: 1	Blatt 2 von 6

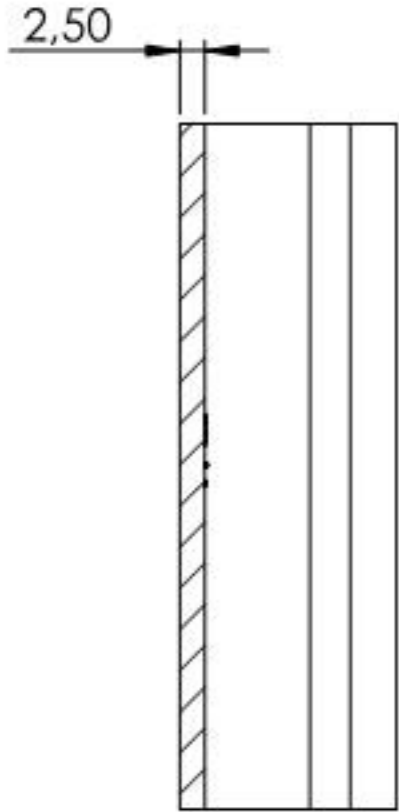
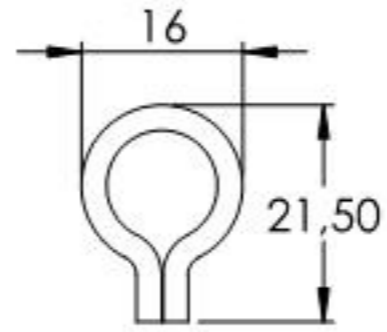

SCHNITT B-B

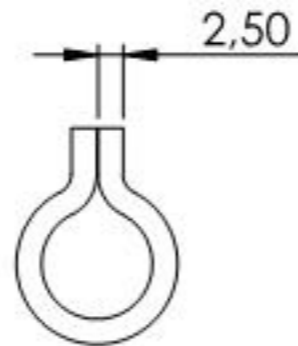
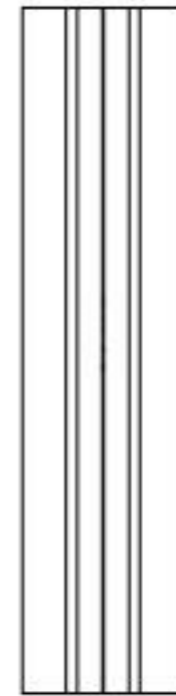
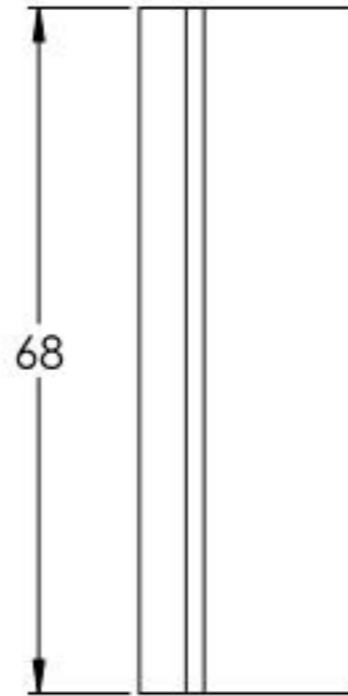
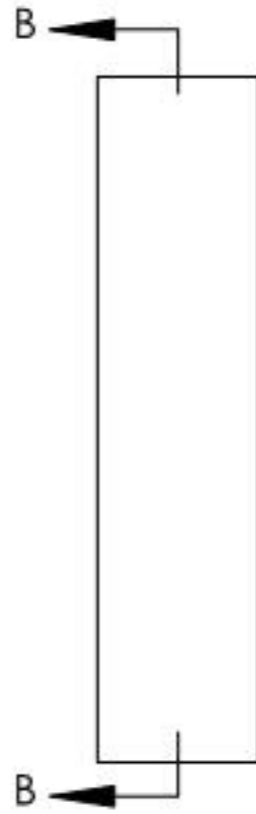

Name	Signatur	Datum	Artikelnummer	Oberfläche: Roh
Ch. Höfig	CH	06.09.2021	402-14 Teil2	
Werkstoff:				Blattformat
1.0037 (S235JR)				A4
Gewicht 0,069 kg		Maßstab: 1:1	Version: 1	Blatt 3 von 6