

Tragkraft: 250kg
Gilt für 2 Bänder

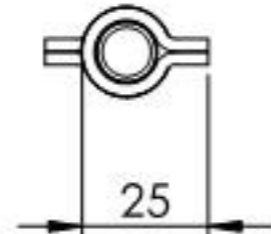

Name	Signatur	Datum	Artikelnummer	Oberfläche: Roh
Ch. Höfig	CH	02.09.2021	415-17	
Werkstoff: 1.0037 (S235JR)				Blattformat A4
Gewicht 0.289 kg		Maßstab: 1:2	Version: 1	Blatt 1 von 6

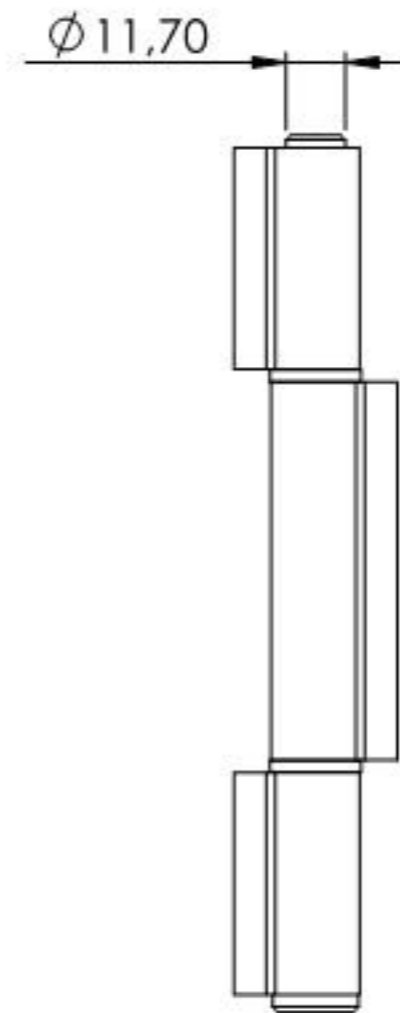
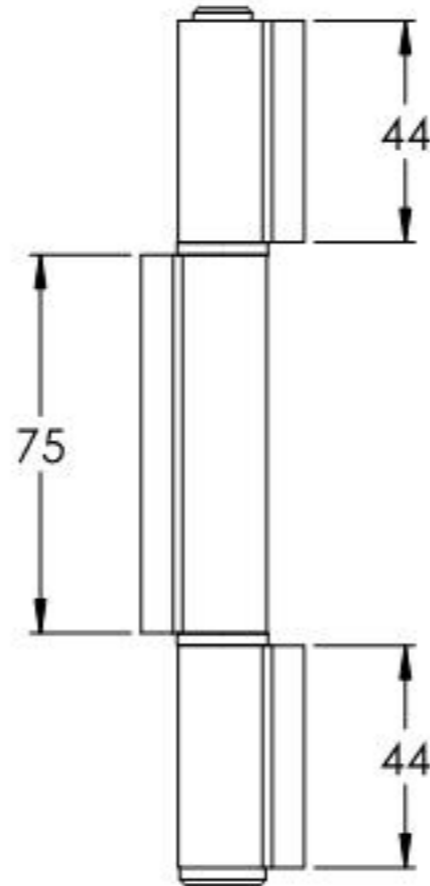
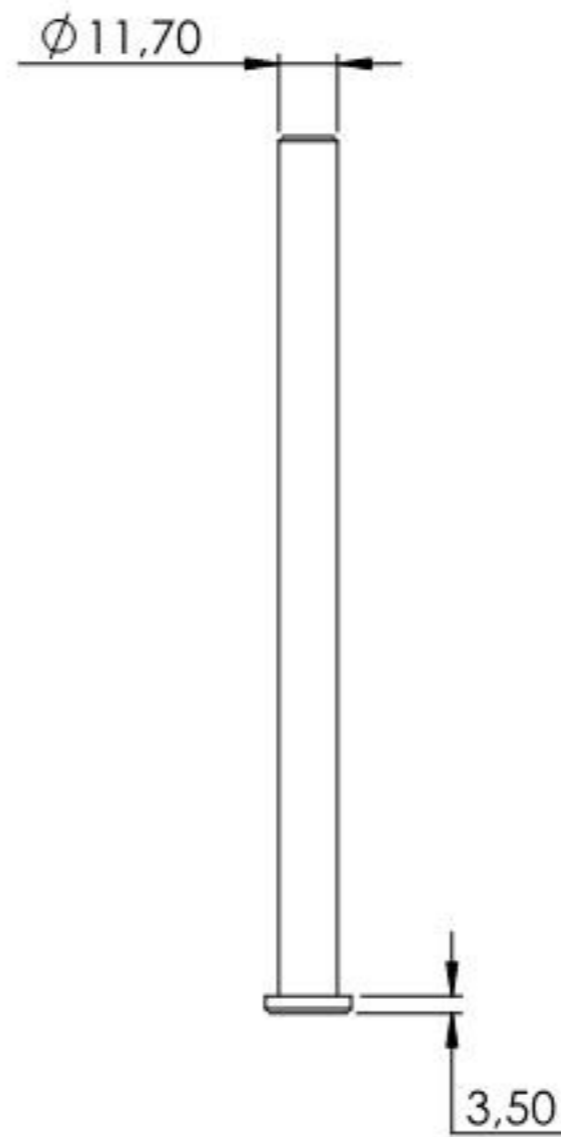
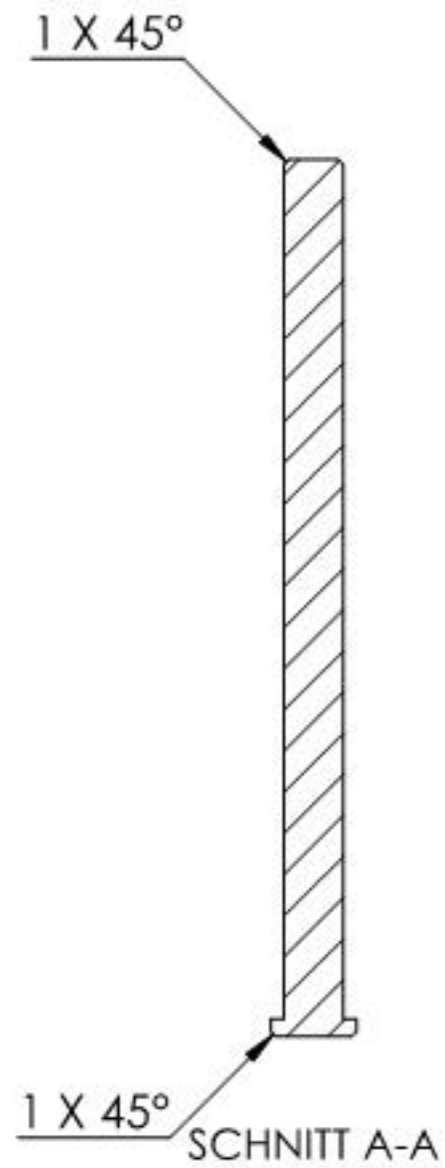

Name	Signatur	Datum	Artikelnummer	Oberfläche: Verankt
Ch. Höfig	CH	02.09.2021	415-17 Teil1	
Werkstoff:				Blattformat
1.0037 (S235JR)				A4
Gewicht 0.149 kg		Maßstab: 1:2	Version: 1	Blatt 2 von 6

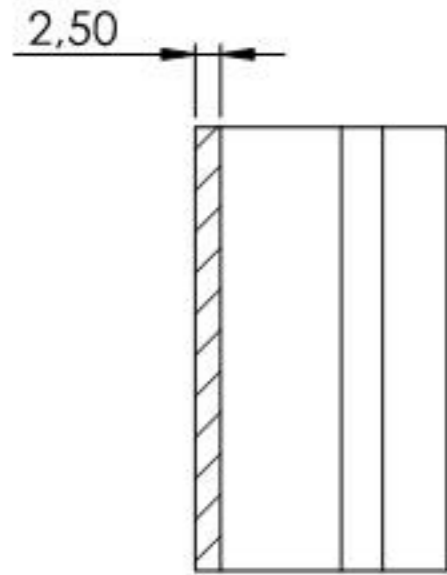
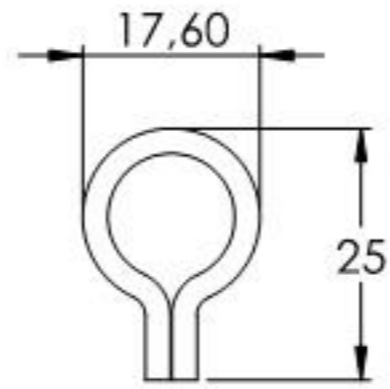

SCHNITT B-B

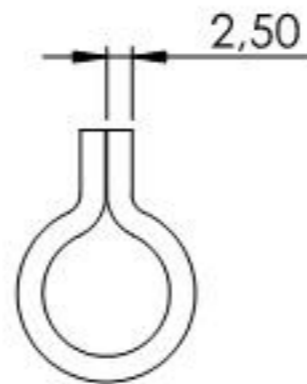
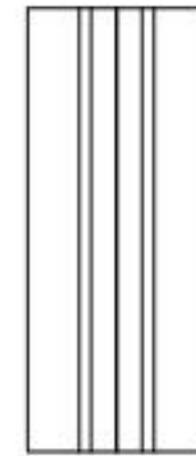
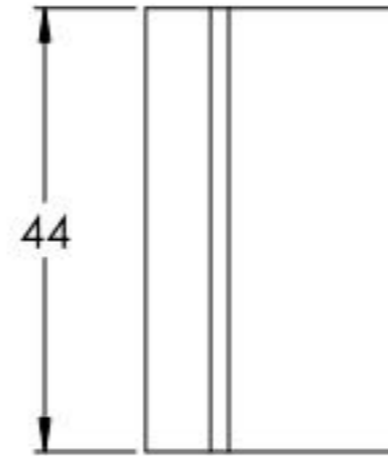

Name	Signatur	Datum	Artikelnummer	Oberfläche: Roh
Ch. Höfig	CH	02.09.2021	415-17 Teil2	
Werkstoff:				Blattformat
1.0037 (S235JR)				A4
Gewicht 0,052 kg		Maßstab: 1:1	Version: 1	Blatt 3 von 6