

SCHNITT A-A

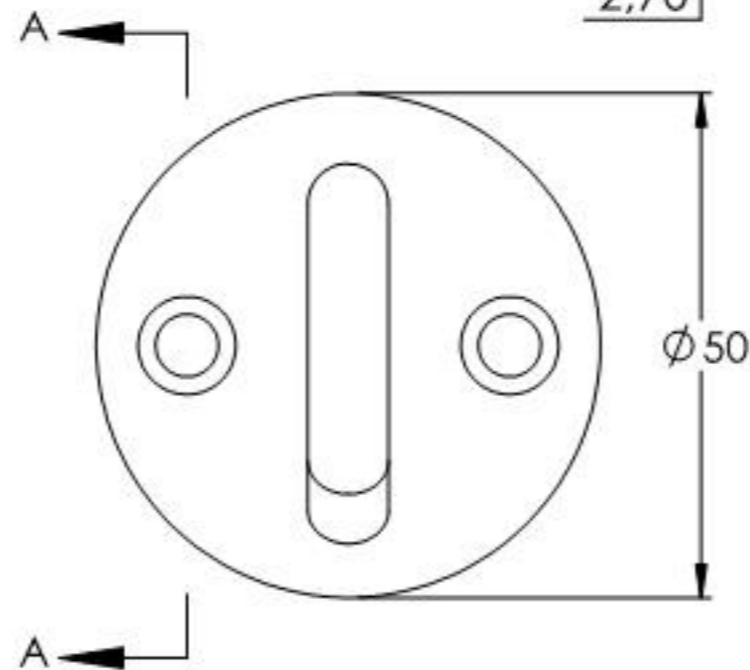

Name	Signatur	Datum	Artikelnummer	Oberfläche: Elektropoliert
Ch. Höfig	CH	17.12.2020	100076008	
Werkstoff:				Blattformat
1.4401/04 (X5CrNiMo17-12-2)				A4
Gewicht 0.064 kg		Maßstab: 1:1	Version: 1	Blatt 1 von 1