

Name	Signatur	Datum	Artikelnummer	Oberfläche: Geschliffen Korn 240
Ch. Höfig	CH	25.08.2021	121-M16-V4A	
Werkstoff:				Blattformat
1.4301 (X5CrNi18-10)				A4
Gewicht 0.896 kg		Massstab: 1:2.5	Version: 1	Blatt 1 von 8

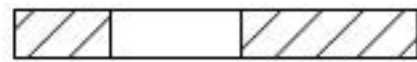

SCHNITT A-A

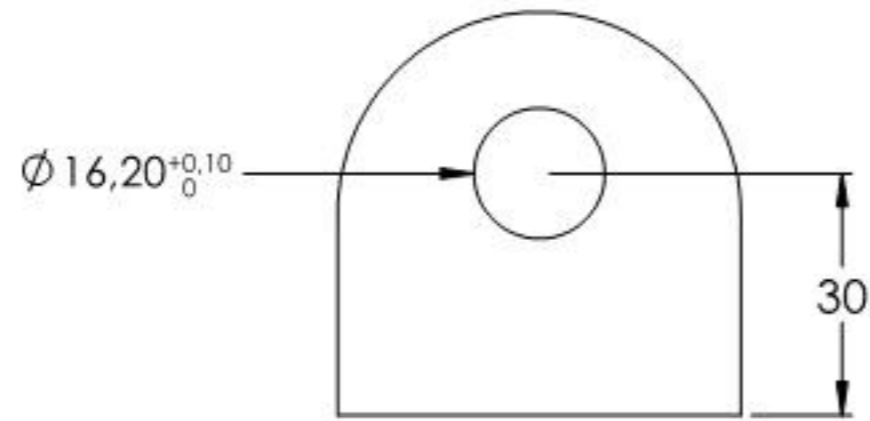
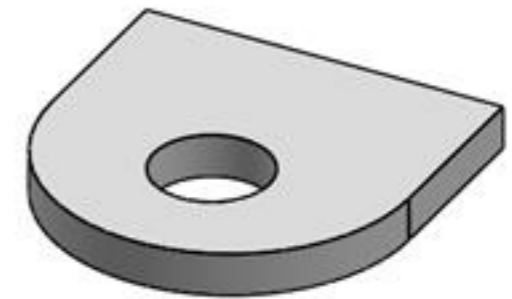
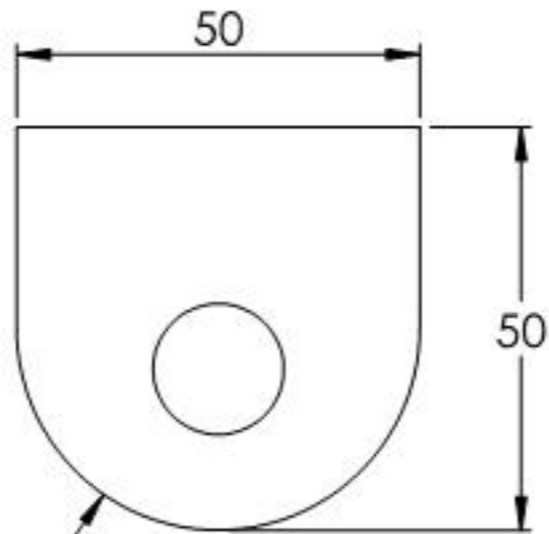
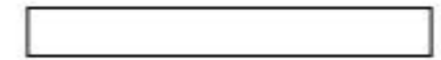
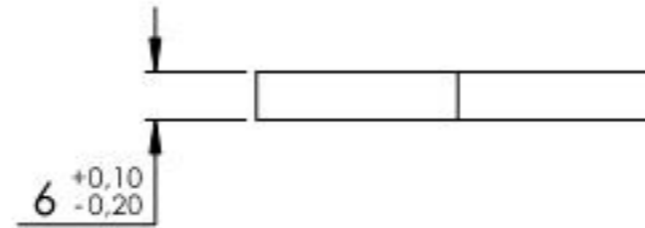
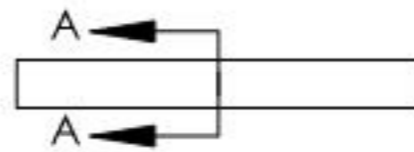

Name	Signatur	Datum	Artikelnummer	Oberfläche: Geschliffen Korn 240
Ch. Höfig	CH	25.08.2021	121-M16-V4A Teil1	
Werkstoff:				Blattformat
1.4401/04 (X5CrNiMo17-12-2)				A4
Gewicht 0,097 kg		Maßstab: 1:1,25	Version: 1	Blatt 2 von 8

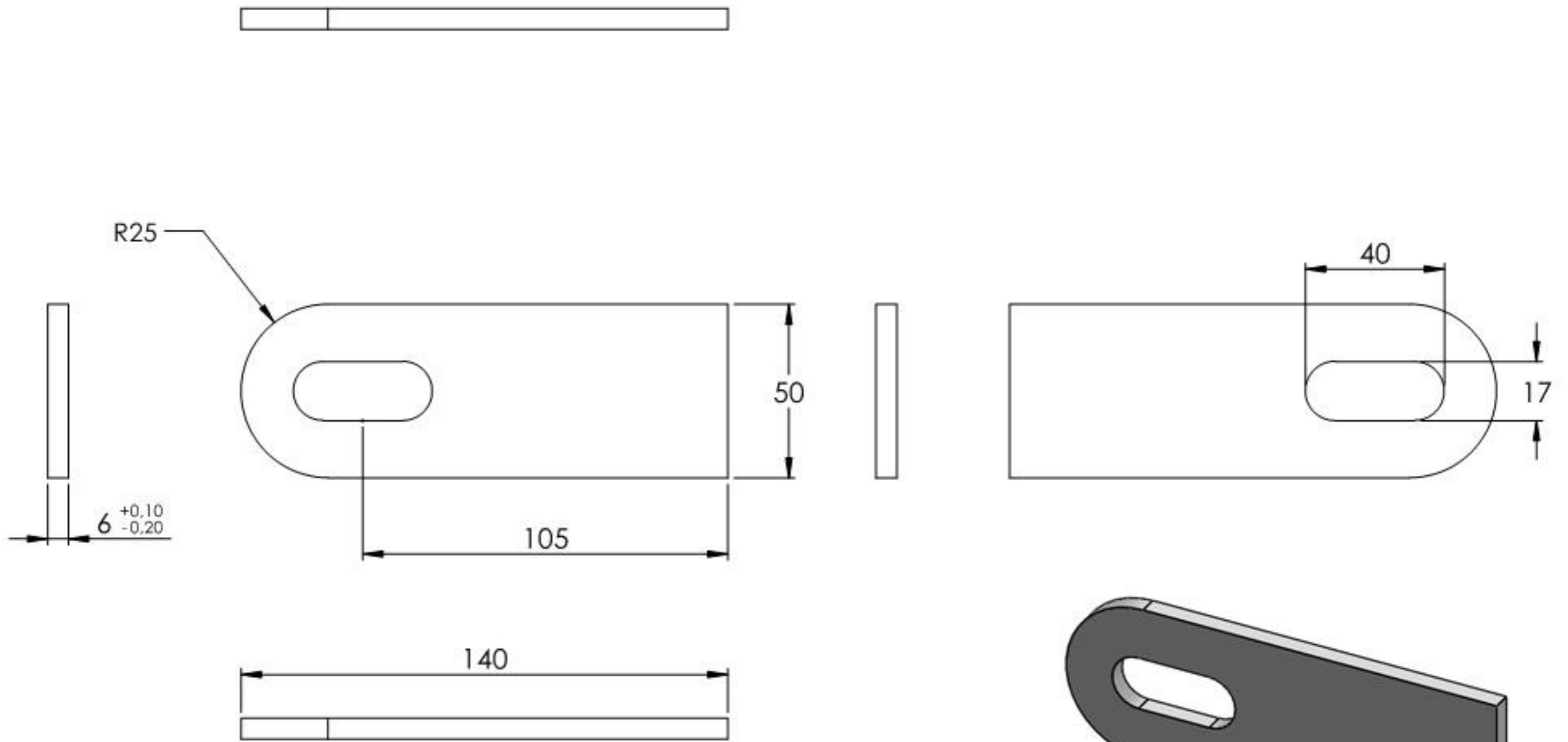

Name	Signatur	Datum	Artikelnummer	Oberfläche: Geschliffen Korn 240
Ch. Höfig	CH	25.08.2021	121-M16-V4A Teil2	
Werkstoff:				Blattformat
1.4401/04 (X5CrNiMo17-12-2)				A4
Gewicht 0.293 kg		Maßstab: 1:1.75 Version: 1		Blatt 3 von 8