

DIN 914
M8x45

SCHNITT A-A

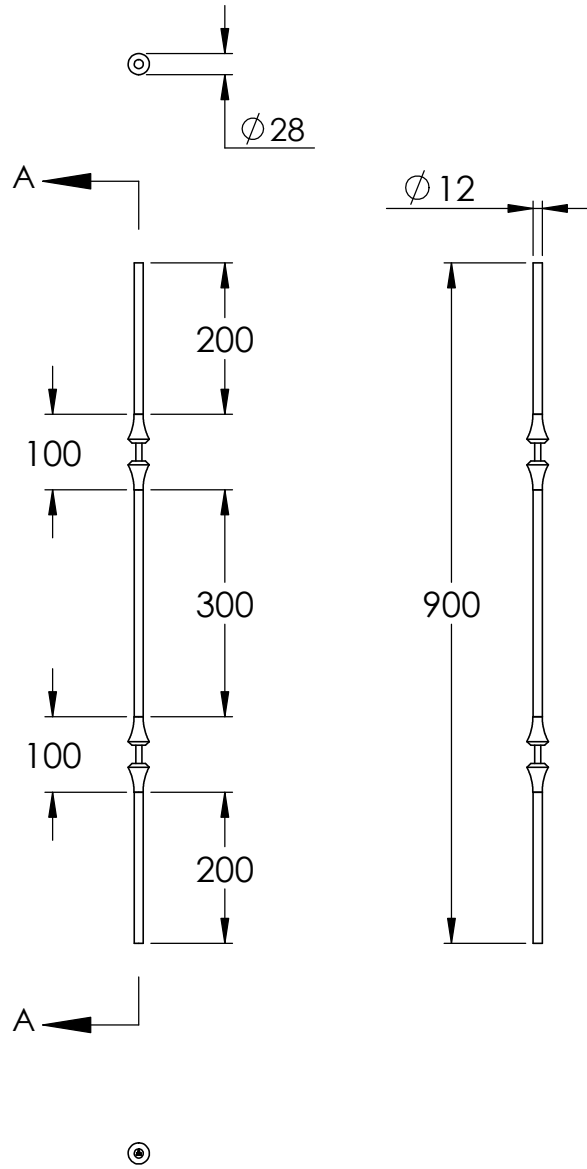

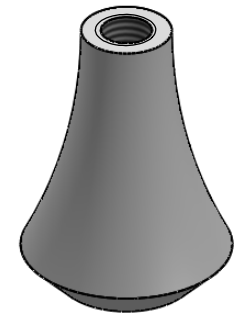

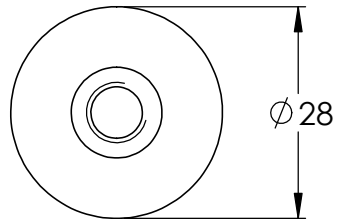
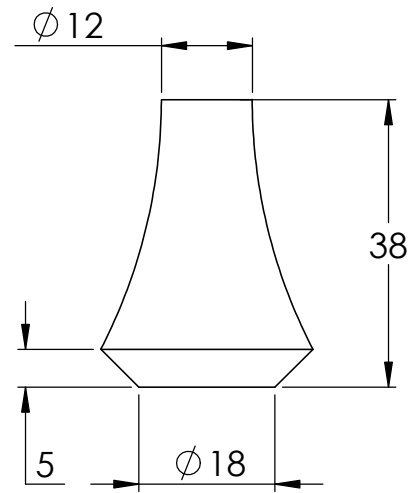
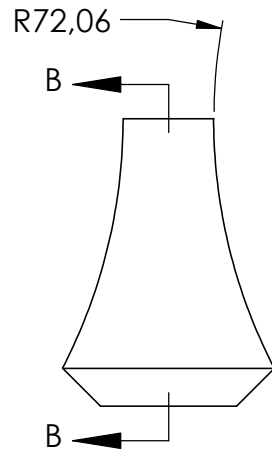
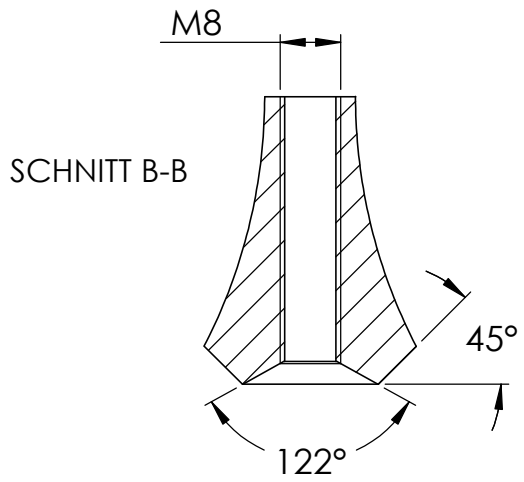
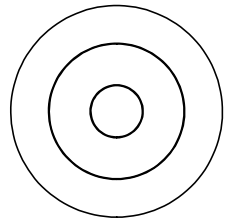
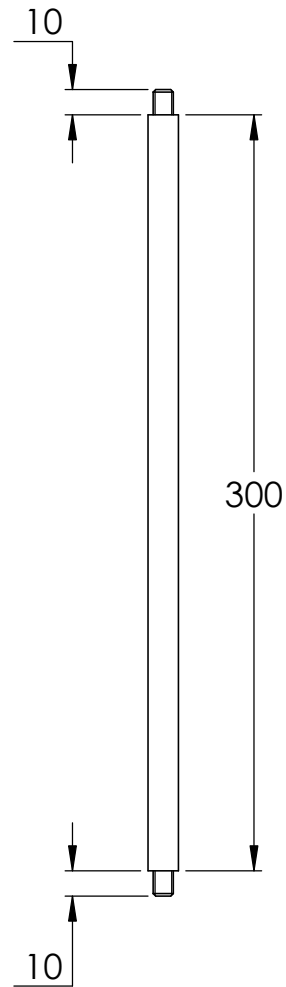
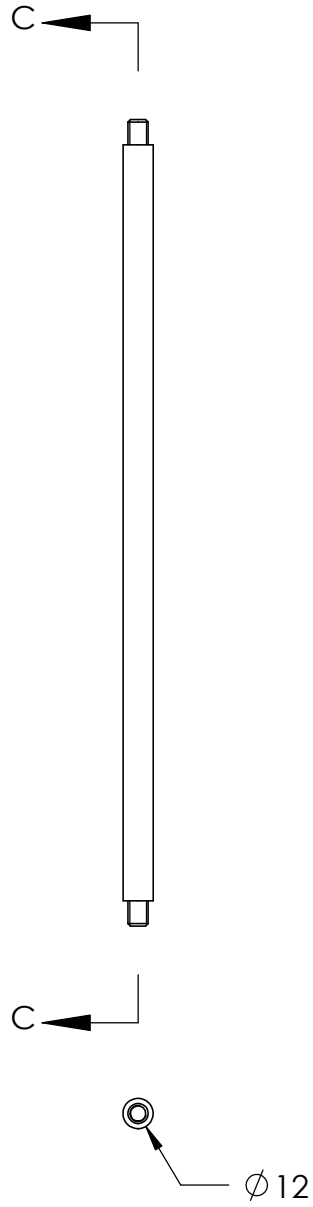
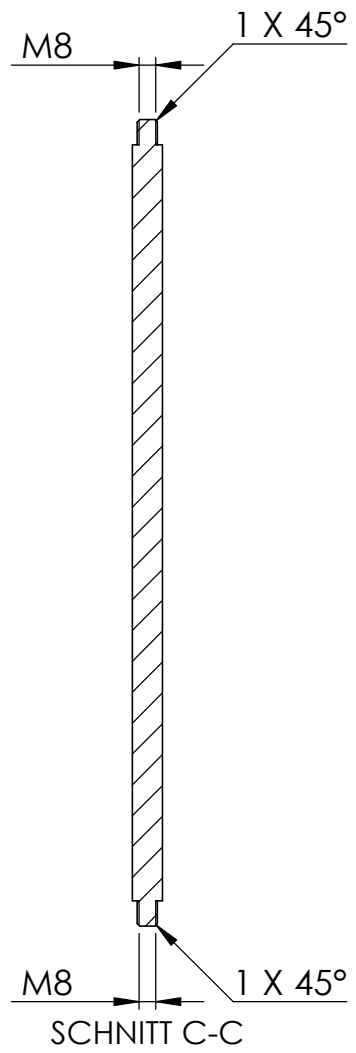

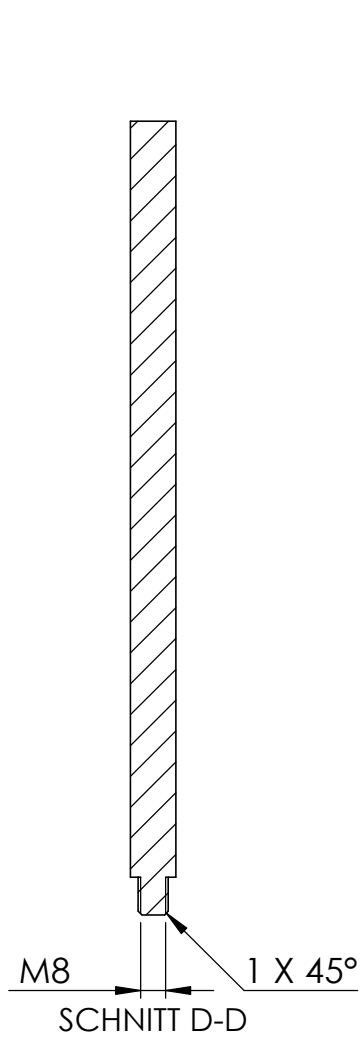

D



D

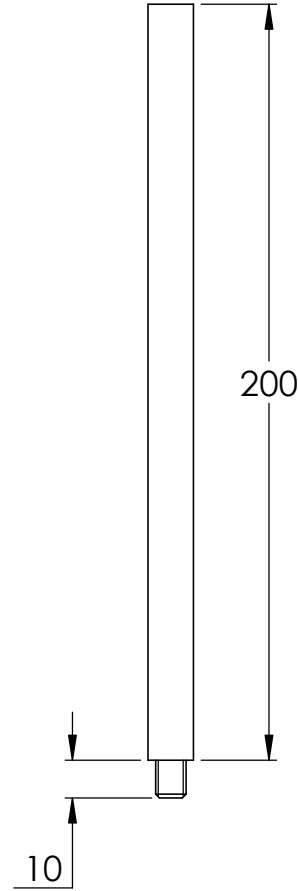

Ø 12

A circle with a diameter symbol (Ø) and the number 12, representing the diameter of the shaft.



4

DIN 914 M8x45

2

