

$\varnothing 12,50$

M8

7

40,18

19,68

R2

3°

3

1

3,50

$\varnothing 4,20$

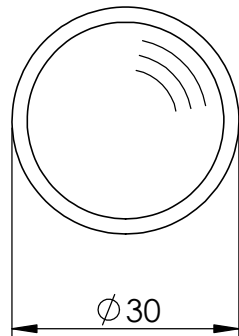

$\varnothing 30$

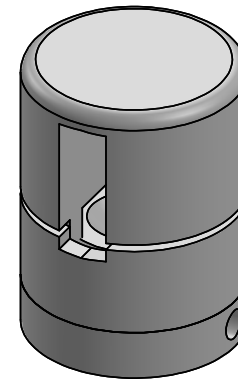

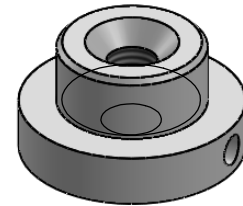
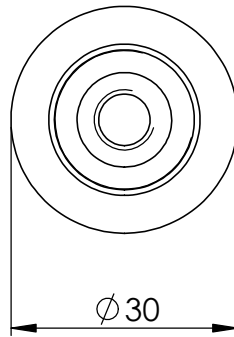
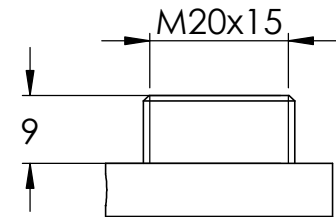
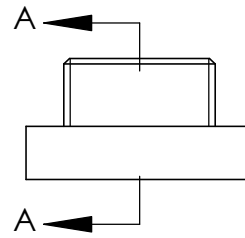
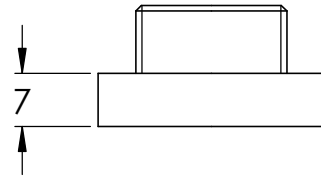
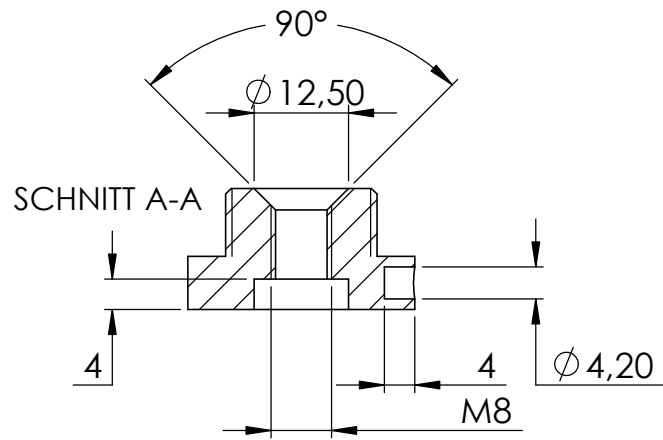
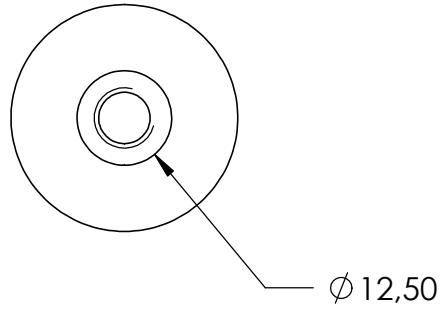

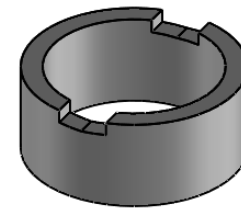
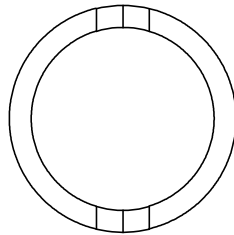
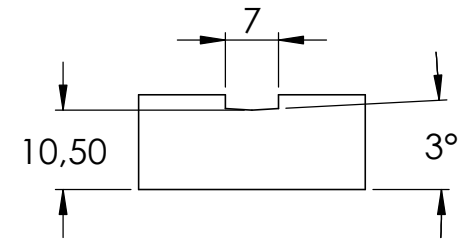
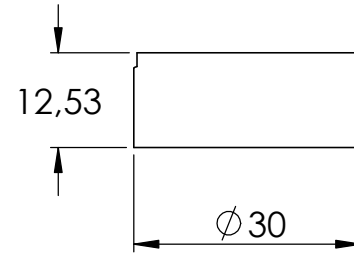
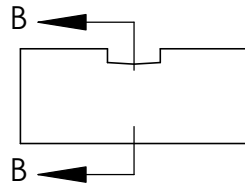
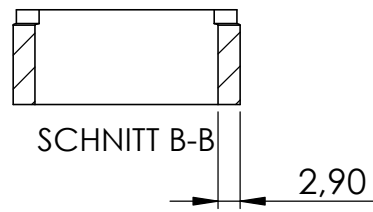
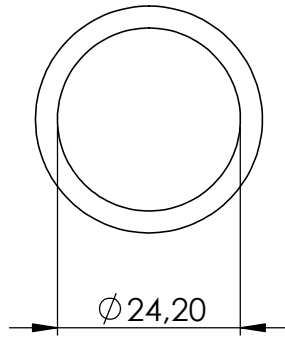

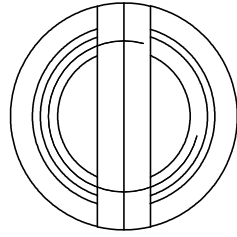

SCHNITT C-C

